

UNITED KINGDOM

DACH COUNTRIES

BENELUX

NORDICS

THE RIVA COLLECTION

Alluring Designs
Captivating Details
Luxury that Endures



PRICE BOOK 2025

GRAFF[®]
Art of Bath





GRAFF

PASSIONATELY GREEN

Bordering a beautiful national park, rich with flora and fauna, GRAFF's manufacturing facility is actively and thoroughly green. Nature's glory surrounds us as we guard and honor the precious resources the earth offers. We passionately protect the environment, meeting strict EMS and conservation standards to ensure the vitality of a green present and future. At our manufacturing facility and everywhere else GRAFF is present in the world, we treat nature as a cherished member of our family and community.

GRÜN AUS LEIDENSCHAFT

Die Produktionsstätte von GRAFF grenzt an einen wunderschönen Nationalpark reich an Flora und Fauna – an ein Gebiet, das lebendig und durch und durch grün ist. Umgeben von der herrlichen Natur, schützen und ehren wir die wertvollen Ressourcen der Erde. Wir schützen die Umwelt mit Leidenschaft und erfüllen strenge EMS- und Naturschutzstandards, um die Vitalität einer grünen Gegenwart und Zukunft zu gewährleisten. In unserer Produktionsstätte und überall sonst auf der Welt, wo GRAFF vertreten ist, behandeln wir die Natur wie ein geschätztes Mitglied unserer Familie und Gemeinschaft.

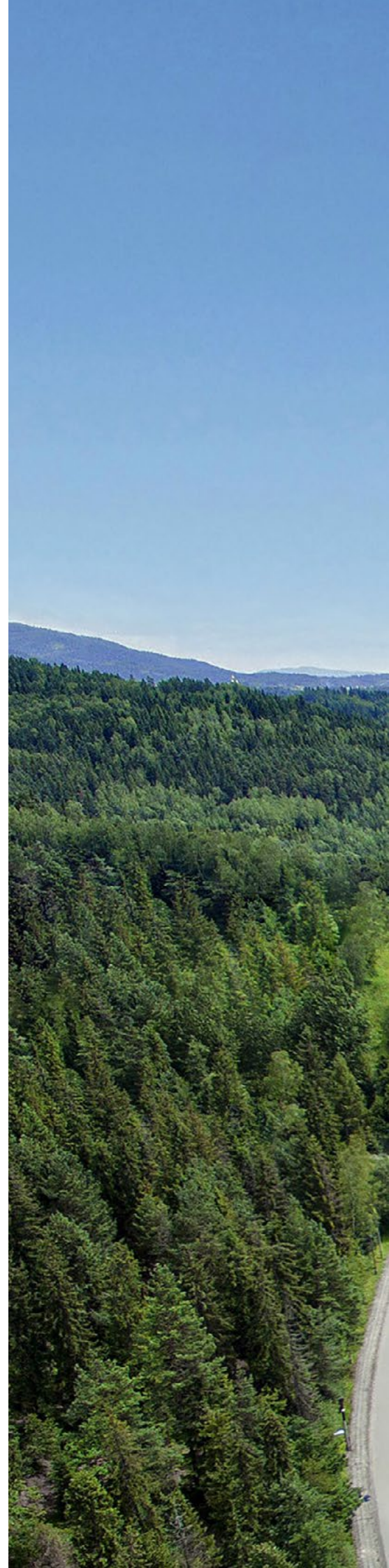

THE GREEN & SUSTAINABLE COMPANY

**DAS GRÜNE, NACHHALTIGE
UNTERNEHMEN**



GRAFF

THE STORY BEGINS

Mr. Ziggy Kulig, President, GRAFF, envisions making a difference in the industry by combining his European creativity with American engineering expertise.



NO-LEAD PRODUCTS

The combination of a European background and American culture shapes Kulig's desire to manufacture unique, designer eco-friendly products.



NEW MANUFACTURING PLANT & ISO 9001

Adjoining a national park and protecting the environment, GRAFF acquires a manufacturing plant that meets strict EMS and conservation standards. In 1996, GRAFF achieves ISO 9001 certification for its quality management systems.

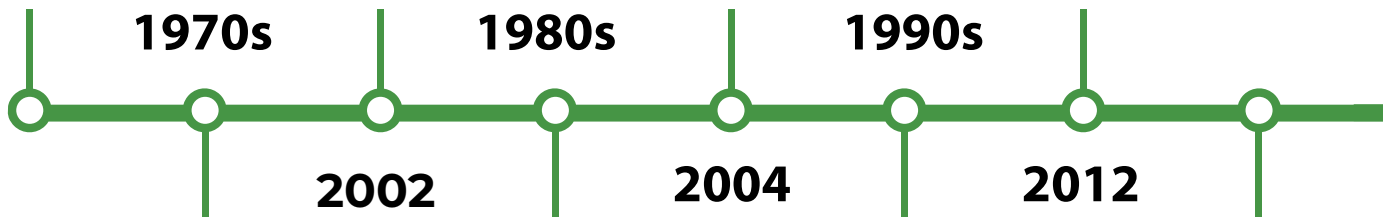

THE DEBUT OF DIFFERENCE

More than a product, GRAFF's designs are masterpieces, representing a philosophy of style and perfection.



ISO 14001 CERTIFICATION

GRAFF obtains the ISO 14001 certification for its production processes.



GRAFF RAISES THE BAR

All GRAFF products adhere to eco-friendly standards by automatically including a water-saving device.

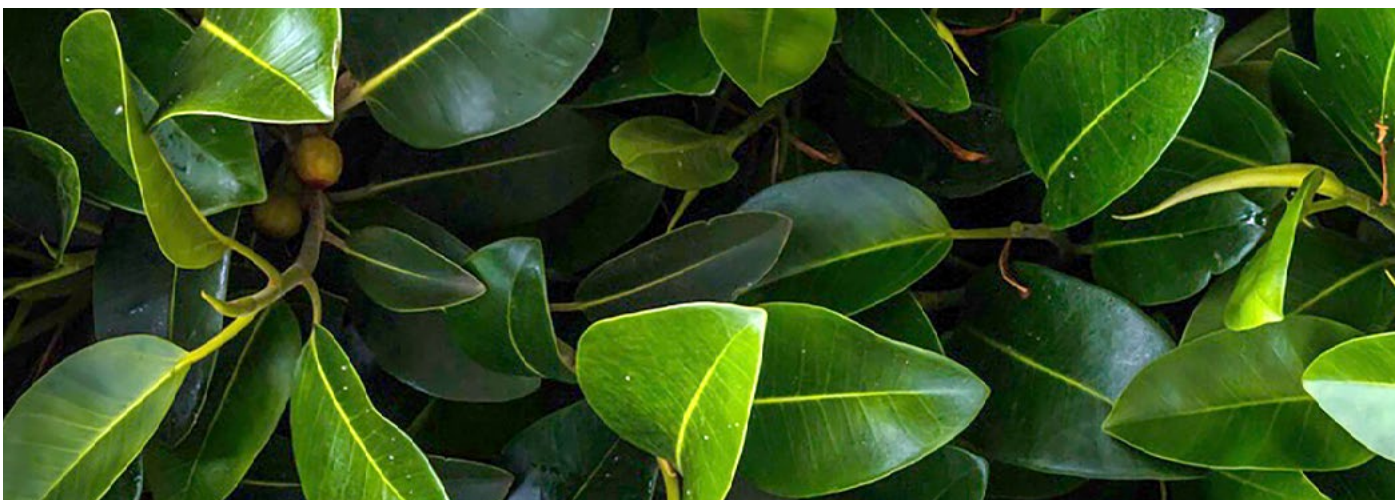

SUSTAINABILITY TIMELINE

WELLNESS PROGRAM

GRAFF introduces its wellness program, featuring hi-tech luxury products and shower systems equipped with chromotherapy, hydrotherapy and music therapy.



2015

ART OF BATH

GRAFF creates the concept of the Art of Bath, celebrating a culture of wellness in the most private living spaces.



2016

GRAFF GROWS

With over 400 new models and more than 25 collections, in 21 luxurious finishes, GRAFF grows its worldwide sales network.



2020

2021

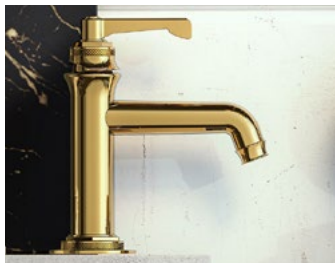

GRAFF BECOMES GREENER

Looking to the future, GRAFF continues to forge new paths with green growth.

2022



NEW PVD FINISHES

GRAFF expands its line of ecofriendly PVD finishes.

2023



ART OF KITCHEN

GRAFF launches the ART OF KITCHEN and adds more kitchen collections with water-saving aerators.

WELLNESS SANCTUARY

GRAFF develops the RIVA Collection for the shower. The modular elements allow the customer to customize the composition.

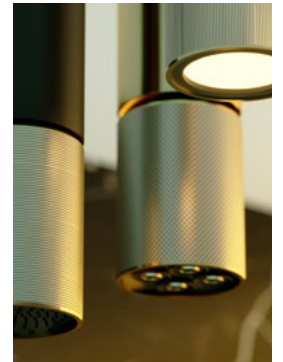

2024



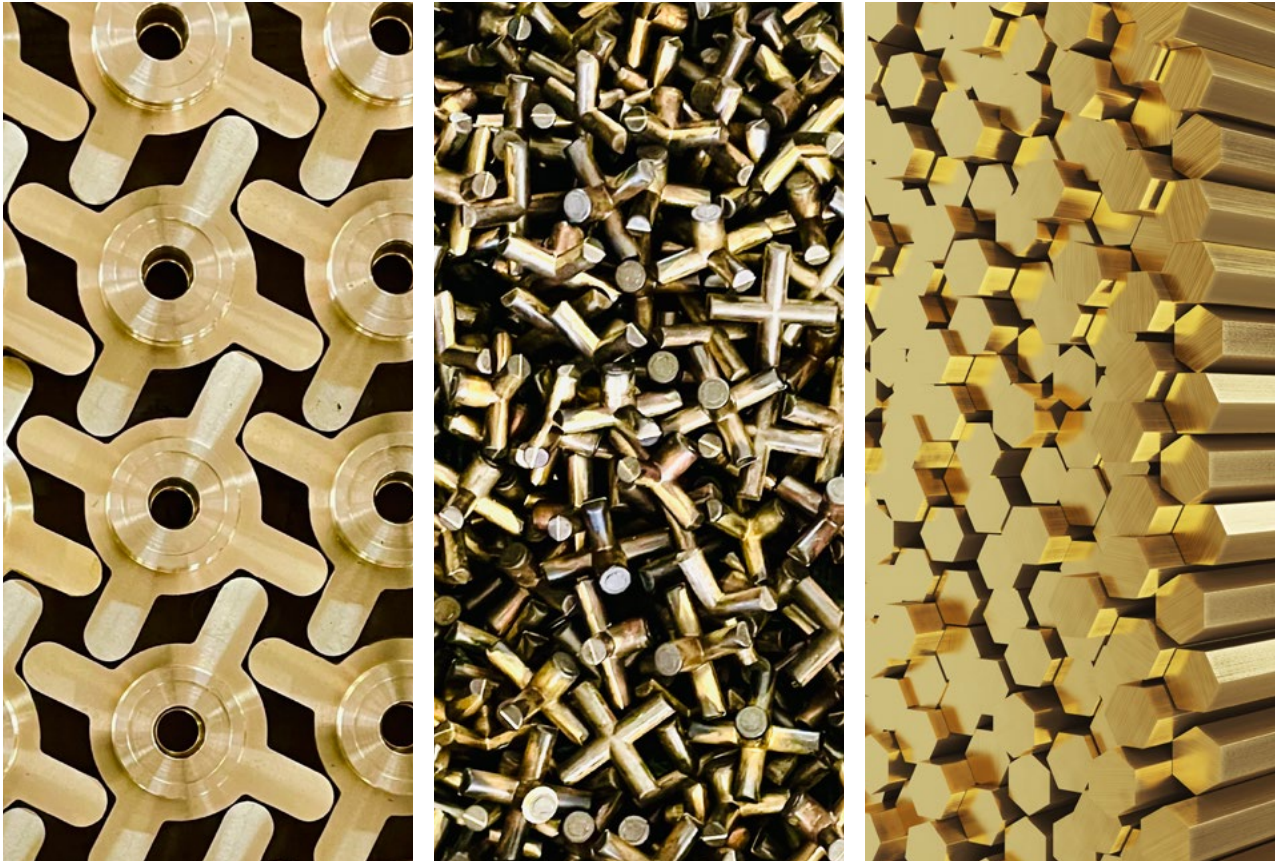

GRAFF

ALL IN-HOUSE MANUFACTURING

With each product being engineered, manufactured and inspected in-house, the company holds total control of every step in the manufacturing process. Manufacturing uses both high-precision tools and irreplaceable human artistry. GRAFF products are made by hand and are a combination of many skills.

KOMPLETTE EIGENFERTIGUNG

Da jedes Produkt im eigenen Haus entwickelt, hergestellt und geprüft wird, haben wir die vollständige Kontrolle über jeden Schritt des Herstellungsprozesses. Bei der Fertigung kommen sowohl hochpräzise Werkzeuge als auch unersetzliche menschliche Kunstfertigkeit zum Einsatz. GRAFF Produkte werden von Hand geschaffen und sind eine Symbiose aus vielfältigen Kompetenzen.

ZERO WASTE LEAN MANUFACTURING

**GRAFF – ABFALLFREIE UND
SCHLANKE PRODUKTION**



GRAFF's manufacturing system is based on an innovative Lean Manufacturing management concept. By eliminating waste in the form of time, energy, and materials, each process achieves substantial efficiencies.

Das Fertigungssystem von GRAFF basiert auf einem innovativen Lean Manufacturing Management-Konzept. Durch Zeit-, Energie- und Materialminimierung werden in jedem Prozess erhebliche Effizienzsteigerungen erzielt.

GRAFF

THE HIGHEST QUALITY LEAD-FREE, ENVIRONMENT FRIENDLY PRODUCTS

Beautiful design cannot exist without sustainability. GRAFF adheres to the high standards of the ISO 14001 EMS to protect the environment for generations to come.

BLEIFREIE, UMWELTFREUNDLICHE PRODUKTE VON HÖCHSTER QUALITÄT

Gute Gestaltung und Nachhaltigkeit gehen Hand in Hand. GRAFF hält sich an die hohen Standards der ISO 14001 EMS (Environmental Management Systems), um die Umwelt für kommende Generationen zu schützen.







GRAFF WORLDWIDE

GRAFF – WELTWEIT



GRAFF'S luxurious designs are an integral element of the best global hotel and resort brands, homes, and villas, complementing the architecture and design of the culinary space. GRAFF's exclusive showrooms in metropolises around the world showcase the brand's cutting-edge collections and artistic vision.

Leading international architects and designers incorporate the GRAFF philosophy in their award-winning interiors, creating kitchens of transcendent beauty and versatility.

Die luxuriösen Designs aus dem Hause GRAFF sind integraler Bestandteil der weltweit besten Hotel- und Ressortmarken, einzigartiger Residenzen und Villen und ergänzen perfekt die Architektur und das Design des Bades. Die exklusiven Ausstellungsräume von GRAFF in den Metropolen der Welt inszenieren die innovativen Kollektionen und die künstlerische Vision der Marke.

Führende internationale Architekten und Designer integrieren die GRAFF Philosophie in ihre preisgekrönten Interieurs und schaffen so individuelle Wellness-Erlebnisräume von einzigartiger Schönheit und Harmonie.

AUSTRIA
AUSTRALIA
BELGIUM
CANADA
CHINA
COSTA RICA
CZECH REPUBLIC
ESTONIA
FRANCE
GERMANY
GREECE
HONG KONG
INDIA
INDONESIA
ITALY
LITHUANIA
LUXEMBOURG
MALAYSIA
MALTA
MEXICO
MOROCCO
NEW ZEALAND
POLAND
PORTUGAL
ROMANIA
RUSSIA
SINGAPORE
SLOVAKIA
SOUTH AFRICA
SOUTH KOREA
SPAIN
SWITZERLAND
TAIWAN
THAILAND
TURKEY
UKRAINE
UNITED ARAB
EMIRATES
UNITED KINGDOM
UNITED STATES
VIETNAM

GRAFF HANDCRAFTED FINISHES

GRAFF'S HANDGEFERTIGTE OBERFLÄCHEN

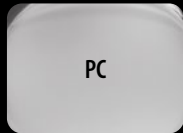

PC

Polished Chrome
Poliertes Chrom

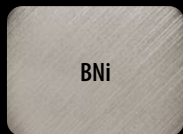

BNi

Brushed Nickel
Gebürstetes Nickel



WT

Matte White
Weiss Matt



MBK

Matte Black
Schwarz Matt



PN

Polished Nickel
Poliertes Nickel

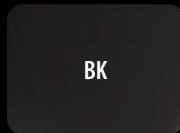

BK

Architectural Black
Architectural Black



SN

Steelnox® Satin Nickel
Seidenglänzendes
Nickel Steelnox®

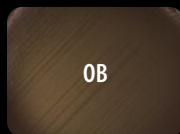

OB

Olive Bronze
Olivebraun

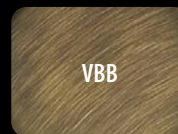

VBB

Vintage Brushed Brass
Messing gebürstet Vintage

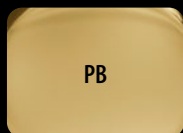

PB

Polished Brass PVD
Poliertes Messing PVD

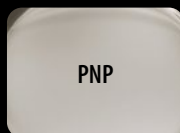

PNP

Polished Nickel PVD
Poliertes Nickel PVD



RG

Polished Rose Gold/ Copper PVD®
Roségold / Poliertes Kupfer PVD®

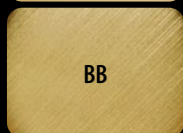

BB

Brushed Brass PVD
Gebürstetes Messing PVD



BNP

Brushed Nickel PVD
Gebürstetes Nickel PVD



BRG

Brushed Rose Gold/Copper PVD®
Roségold / Gebürstetes Kupfer PVD®

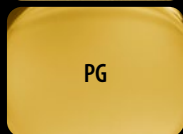

PG

Polished Gold PVD
Poliertes Gold PVD

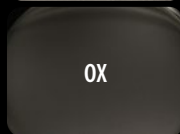

OX

Onyx PVD®
Onyx PVD®

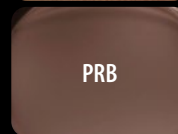

PRB

Polished Tuscan Bronze PVD
Poliertes toskanisch Bronze PVD

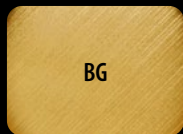

BG

Brushed Gold PVD
Gebürstetes Gold PVD

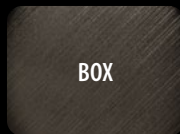

BOX

Brushed Onyx PVD®
Gebürstetes Onyx PVD®

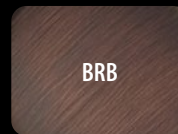

BRB

Brushed Tuscan Bronze PVD
Gebürstetes toskanisch Bronze PVD



SG

Satin Gold PVD
Satingold PVD



WB

Warm Bronze PVD
Warme Bronze PVD



GM

Gunmetal PVD
Gunmetal PVD



AU

Polished Gold 24K
Poliertes Gold 24K



BAU

Brushed Gold 24K
Gebürstetes Gold 24K

GRAFF finishes - Oberflächen GRAFF		Warranty years - Garantie in Jahren	
Finish acronym Art der Oberfläche	Finish acronym Abkürzung der Oberfläche	Residential Privat	Commercial Gewerblich
Galvanic • Galvanisch	PC/BNi/PN	5	3
Galvanic 24k gold • Galvanisch Gold 24 K	AU-24K/BAU-24K	1	0
Powder coating • Pulverbeschichtung	BK/WT/SN/OB/MBK	3	2
Liquid epoxy coating • Flüssige Epoxyd-Beschichtung	VBB	2	1
PVD	PB/BB/PG/BG/SG/PNP/BNP/OX/ BOX/GM/RG/BRG/PRB/BRB/WB	15	10

EN For hospitality and commercial projects please ask for 24K Gold PVD finishes with 10 years warranty.
No claims will be considered for damage to the decorative coating caused by the use of inappropriate or aggressive cleaning agents and procedures.

DE Für Hotel-Projekte und für den gewerblichen Sektor bitte die Oberflächen in Gold 24K PVD wählen, mit 10 Jahren Garantie.
Die Garantie deckt nicht die Schäden der Oberflächen, die durch übermäßiges Reiben und durch Einsatz von aggressiven Reinigungsmitteln hervorgerufen wurden.

EN Consistent cleaning and waxing is necessary to keep living finishes to their original luster. Wipe dry with a soft towel after each use and regularly apply a wax to the product. To clean, simply wipe gently with a damp cloth and blot dry with a soft towel. Harsh abrasive cleaners, vinegar-based cleaners, acids, solvents, bleach etc. along with abrasive sponges or cloths should never be used to clean any GRAFF product.

DE Un nettoyage et un cirage réguliers sont nécessaires pour que la finition conserve son éclat d'origine. Essuyer avec un chiffon doux après chaque utilisation et appliquer régulièrement une cire sur le produit. Pour nettoyer, essayez simplement avec un chiffon humide et séchez avec un chiffon doux. Les produits nettoyants abrasifs, nettoyants à base de vinaigre, les acides, les solvants, les javellissants, etc., ainsi que les éponges ou les chiffons abrasifs ne doivent jamais être utilisés pour nettoyer un produit GRAFF.

WARM

WARM

As the name indicates, they tend to make you think of warm things, such as sunlight and heat. Warm colors make you feel more intimate and stimulate the senses. Warm colors consist of red through yellow, hues of tan/brown combinations of these and similar colors.

Wie der Name schon sagt, erinnern sie an warme Dinge, wie z. B. Sonnenlicht und Wärme - warme Farben vermitteln ein Gefühl der Vertrautheit. Warme Farben bestehen aus Rot bis Gelb, Tönen von Bräune/Braun.

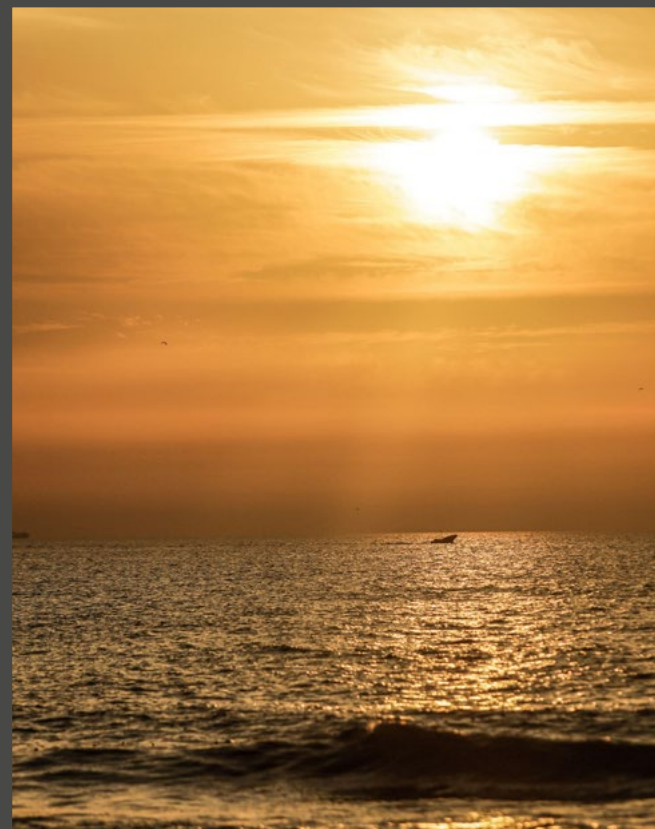



FINISHES

Polished Gold PVD®
Brushed Gold PVD®
Satin Gold PVD®
Gold 24K
Brushed Gold 24K

Polished Rose Gold/Copper PVD®
Brushed Rose Gold/Copper PVD®

Polished Brass PVD®
Brushed Brass PVD®
Vintage Brushed Brass

Polished Tuscan Bronze PVD®
Brushed Tuscan Bronze PVD®
Warm Bronze PVD®
Olive Bronze

COLD

KALT

Cold colors remind you of water, overcast sky, even ice and snow. Cold colors are close to nature and produce feelings of calm and can also be revitalizing. Cold colors are combinations of blue, violet, most grays and combinations of the same.

Kalte Farben erinnern an Wasser, bedeckten Himmel, sogar an Eis und Schnee. Kalte Farben sind naturnah und erzeugen ein Gefühl der Ruhe. Kalte Farben sind Kombinationen aus Blau, Violett, den meisten Grautönen und Kombinationen dieser Farben.

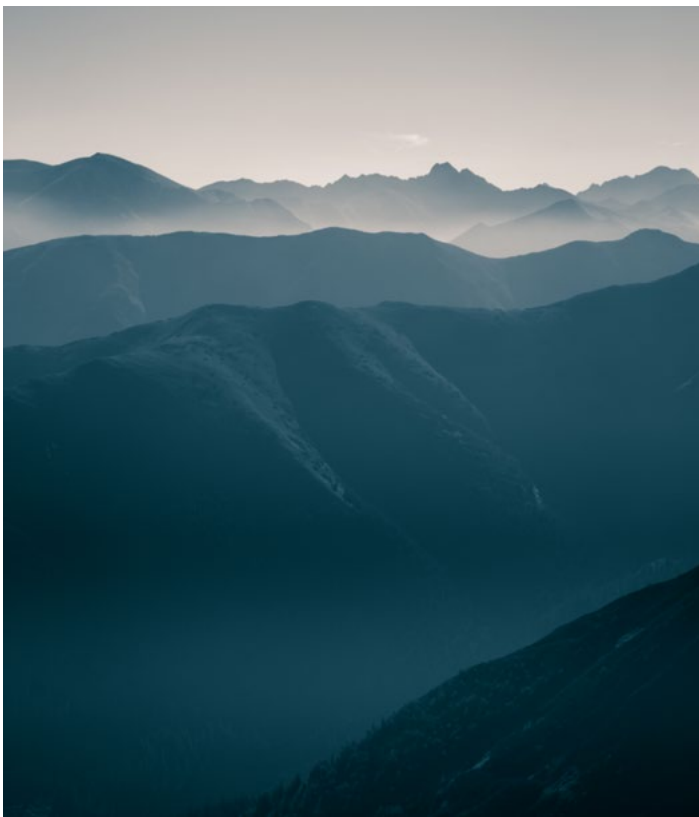
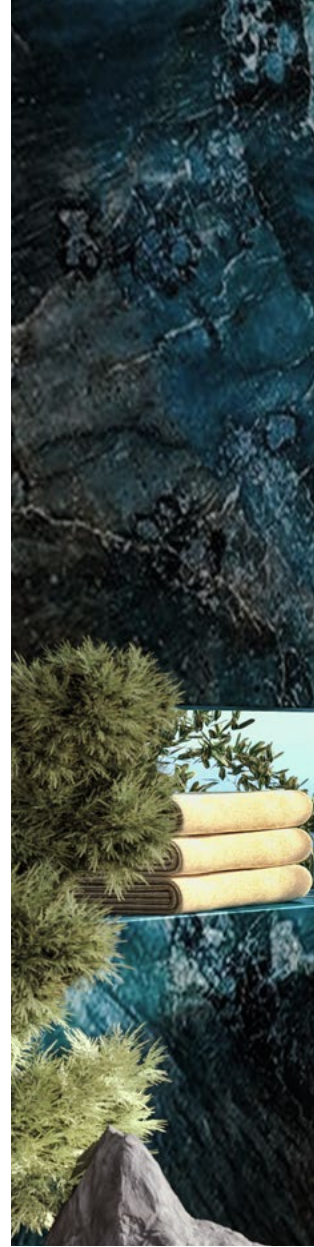

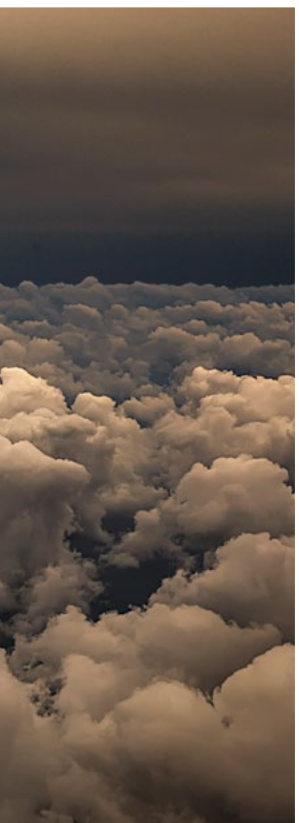

FINISHES

Polished Nickel PVD®
Brushed Nickel PVD®
Polished Nickel
Brushed Nickel

Onyx PVD®
Brushed Onyx PVD®
Gunmetal PVD®

Matte Black
Architectural Black

Polished Chrome
Stelnox® Satin Nickel

Matte White

PC

BNI

PN

WT

BK

MBK

SN

OB

VBB

PB

BB

PG

BG

SG

PNP

BNP

OX

BOX

WB

RG

BRG

PRB

BRB

GM

AU

BAU

GRAFF

CODE	E-18201WTB	*	-	**	
OLD CODE	5746560	-	*	-	**

RIVA COMBINATION EXAMPLES • RIVA KOMBINATIONSBEISPIELE

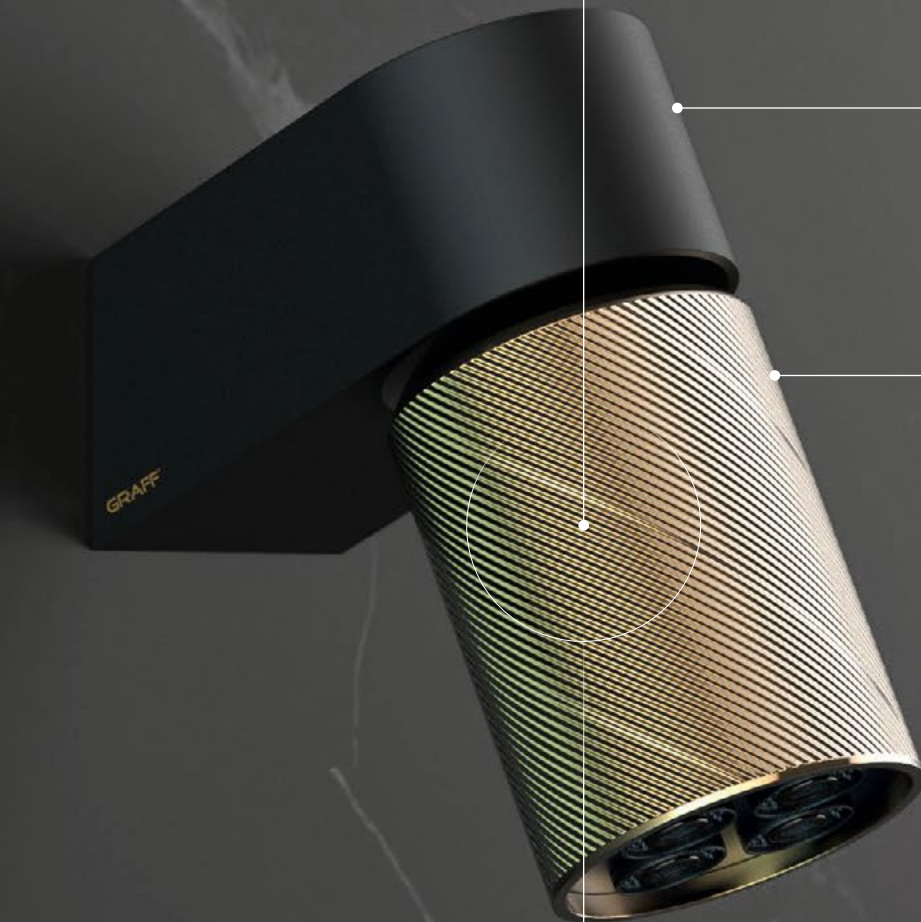
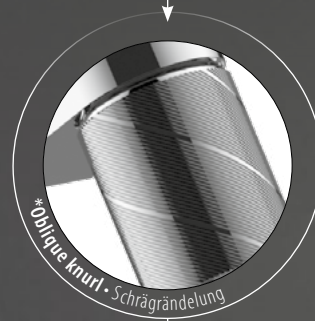
**MBK**Matte Black
Schwarz Matt**PB**Polished Brass PVD
Poliertes Messing PVD

CODE	E-18201WTB	Q	-	MBK/PB	
OLD CODE	5746560	-	Q	-	MBK/PB

- * **D - Diamond knurl** • Diamanträndelung
- F - Fluted** • Rillenrändelung
- Q - Oblique knurl** • Schrägrändelung
- P - Smooth** • Ohne Rändelung

** **Please specify finish** • Bitte die Oberfläche auswählen

Combinations Examples



CODE	E-18013HA	D	-	BB/PB/OX	-T
OLD CODE	5739500	-	D	-	BB/PB/OX

CODE	E-18013HA	*	-	**	-T
OLD CODE	5739500	-	*	-	**



MBK	PB
Matte Black Schwarz Matt	Polished Brass PVD Poliertes Messing PVD



Only in OX, regardless of other selected finishes - Nur in OX, unabhängig von anderen gewählten Oberflächen

OX
Onyx PVD® Onyx PVD®

CODE	E-18013HA	D	-	MBK/PB	-T
OLD CODE	5739500	-	D	-	MBK/PB

TABLE OF CONTENTS

INHALTSVERZEICHNIS

The RIVA Collection	22
The RIVA Scala Collection	32
The RIVA Chandelier Collection	49
Showerhead Flow Rates	52
RIVA Trims	56
Thermostatic Rough Valves	82
Accessories	86
Spare Parts	96



The RIVA Collection

Contemporary Complement

Artfully aligned with contemporary style, RIVA brings a confident design aesthetic and complete immersion in comfort and self-care.

You control the shower experience, shifting angles of flow, choosing mode, light and temperature, creating a customized universe of wellness and luxury.

Perfectly tailor RIVA to personal styles from a selection of contemporary or traditional shower heads, elegant knurled patterns and artisan finishes in exquisite hues.



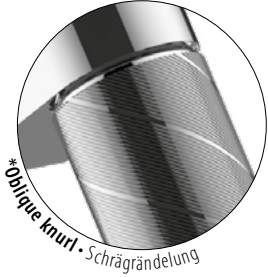
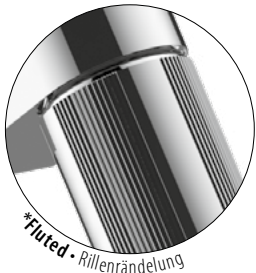
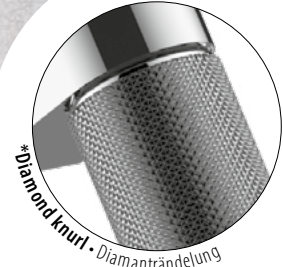

E-18201WCB*.-**	E-18201WCC*.-**	E-18201WCA*.-**	E-18201WCG*.-**	E-18201WCD*.-**	E-18201WCH*.-**
5746400*.-**	5746410*.-**	5746420*.-**	5746130*.-**	5746760*.-**	5746790*.-**
1 040,-	1 040,-	1 040,-	1 040,-	1 704,-	2 447,-
1 248,-	1 248,-	1 248,-	1 248,-	2 045,-	2 936,-
1 405,-	1 405,-	1 405,-	1 405,-	2 300,-	3 303,-
1 560,-	1 560,-	1 560,-	1 560,-	2 556,-	3 670,-
1 768,-	1 768,-	1 768,-	1 768,-	2 896,-	4 159,-
1 873,-	1 873,-	1 873,-	1 873,-	3 066,-	4 404,-

PC
BNi PN WT BK MBK
SN OB VBB
PB BB PG BG SG PNP BNP OX
BOX WB BB/OX PRB/BG MBK/PB
RG BRG PRB BRB GM
AU BAU

RIVA Wall-Mount Contemporary 4-Spray Showerhead • Contemporary Kopfbrause mit 4 Strahlen zur Wandmontage

RIVA Wall-Mount Contemporary 6-Jet Showerhead • Contemporary Kopfbrause mit 6 Strahlen zur Wandmontage

RIVA Wall-Mount Contemporary Showerhead • Contemporary Kopfbrause zur Wandmontage

RIVA Wall-Mount Contemporary Cascade Showerhead • Contemporary Kopfbrause mit Wasserfall zur Wandmontage

RIVA Wall-Mount Contemporary LED with Wall-Mount Button • Contemporary LED-Beleuchtung zur Wandmontage

RIVA Wall-Mount Contemporary LED with Wireless Remote • Contemporary LED-Beleuchtung zur Wandmontage mit kabelloser Lichtsteuerung

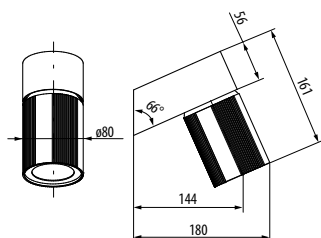
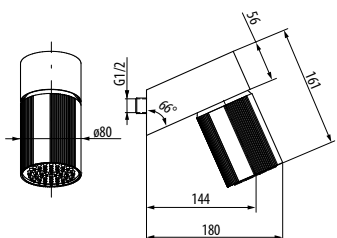
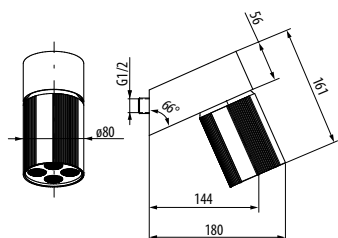

* D - Diamond knurl - Diamanträndelung / F - Fluted - Rillenrändelung / Q - Oblique knurl - Schrägrändelung / P - Smooth - Ohne Rändelung

** Please specify finish - Bitte die Oberfläche auswählen



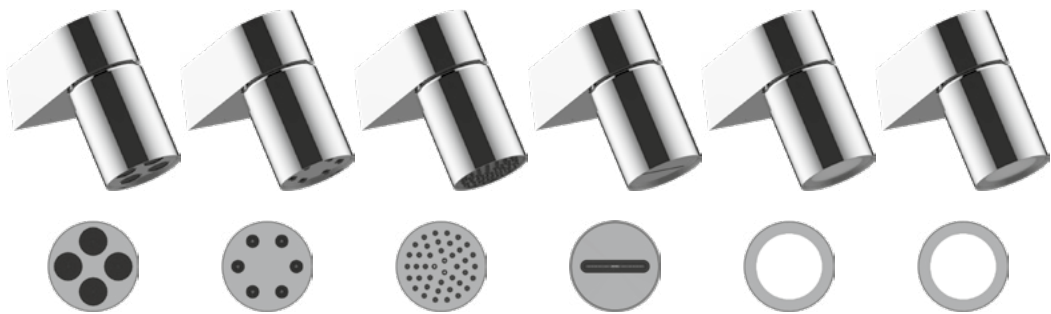

	E-18201WCBP-**	E-18201WCCP-**	E-18201WCAP-**	E-18201WCGP-**	E-18201WCDP-**	E-18201WCHP-**
	5746400-P-**	5746410-P-**	5746420-P-**	5746130-P-**	5746760-P-**	5746790-P-**
PC	960,-	960,-	960,-	960,-	1 624,-	2 367,-
BNi	1 152,-	1 152,-	1 152,-	1 152,-	1 950,-	2 841,-
PN						
WT						
BK						
MBK						
SN	1 295,-	1 295,-	1 295,-	1 295,-	2 194,-	3 196,-
OB						
VBB						
PB	1 439,-	1 439,-	1 439,-	1 439,-	2 436,-	3 551,-
BB						
PG						
BG						
SG						
PNP						
BNP						
OX						
BOX	1 631,-	1 631,-	1 631,-	1 631,-	2 762,-	4 024,-
WB						
BB/OX						
PRB/BG						
MBK/PB						
RG	1 728,-	1 728,-	1 728,-	1 728,-	2 924,-	4 261,-
BRG						
PRB						
BRB						
GM						
AU						
BAU						

RIVA Wall-Mount Contemporary 4-Spray Showerhead • Contemporary Kopfbrause mit 4 Strahlen zur Wandmontage

RIVA Wall-Mount Contemporary 6-Jet Showerhead • Contemporary Kopfbrause mit 6 Strahlen zur Wandmontage

RIVA Wall-Mount Contemporary Showerhead • Contemporary Kopfbrause zur Wandmontage

RIVA Wall-Mount Contemporary Cascade Showerhead • Contemporary Kopfbrause mit Wasserfall zur Wandmontage

RIVA Wall-Mount Contemporary LED with Wall-Mount Button • Contemporary LED-Beleuchtung zur Wandmontage

RIVA Wall-Mount Contemporary LED with Wireless Remote • Contemporary LED-Beleuchtung zur Wandmontage mit kabelloser Lichtsteuerung

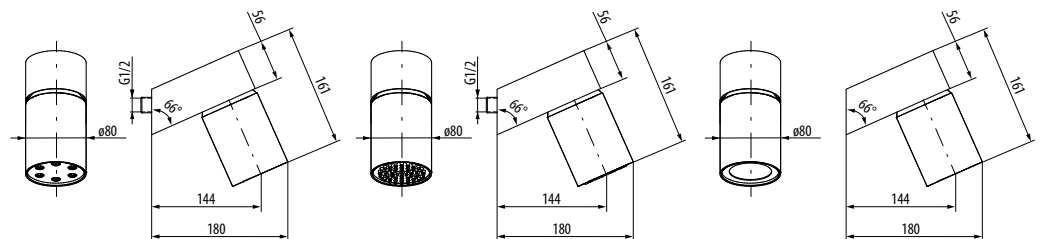

** Please specify finish • Bitte die Oberfläche auswählen

- PC
- BNi
- PN
- WT
- BK
- MBK
- SN
- OB
- VBB
- PB
- BB
- PG
- BG
- SG
- PNP
- BNP
- OX
- BOX
- WB
- BRG
- PRB
- BRB
- GM
- AU
- BAU





	E-18201WTB*.-**	E-18201WTC*.-**	E-18201WTA*.-**	E-18201WTG*.-**	E-18201WTD*.-**	E-18201WTH*.-**
	5746560*.-**	5746570*.-**	5746580*.-**	5746140*.-**	5746770*.-**	5746800*.-**
PC	1 147,-	1 147,-	1 147,-	1 147,-	1 799,-	2 542,-
BNi PN WT BK MBK	1 377,-	1 377,-	1 377,-	1 377,-	2 159,-	3 050,-
SN OB VBB	1 548,-	1 548,-	1 548,-	1 548,-	2 429,-	3 432,-
PB BB PG BG SG PNP BNP OX	1 721,-	1 721,-	1 721,-	1 721,-	2 698,-	3 813,-
BOX WB BB/OX PRB/BG MBK/PB	1 950,-	1 950,-	1 950,-	1 950,-	3 058,-	4 321,-
RG BRG PRB BRB GM	2 065,-	2 065,-	2 065,-	2 065,-	3 239,-	4 575,-
AU BAU						

RIVA Wall-Mount Traditional 4-Spray Showerhead • Traditional Kopfbrause mit 4 Strahlen zur Wandmontage

RIVA Wall-Mount Traditional 6-Jet Showerhead • Traditional Kopfbrause mit 6 Strahlen zur Wandmontage

RIVA Wall-Mount Traditional Showerhead • Traditional Kopfbrause zur Wandmontage

RIVA Wall-Mount Traditional Cascade Showerhead • Traditional Kopfbrause mit Wasserfall zur Wandmontage

RIVA Wall-Mount Traditional LED with Wall-Mount Button • Traditional LED-Beleuchtung zur Wandmontage

RIVA Wall-Mount Traditional LED with Wireless Remote • Traditional LED-Beleuchtung zur Wandmontage mit kabelloser Lichtsteuerung

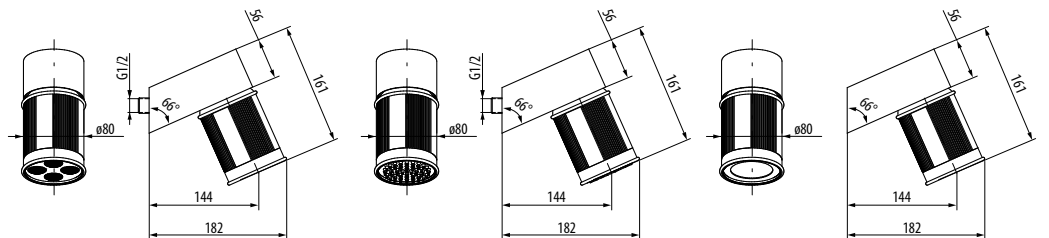

* D - Diamond knurl • Diamanträndelung / F - Fluted • Rillenrändelung / Q - Oblique knurl • Schrägrändelung / P - Smooth • Ohne Rändelung

** Please specify finish • Bitte die Oberfläche auswählen



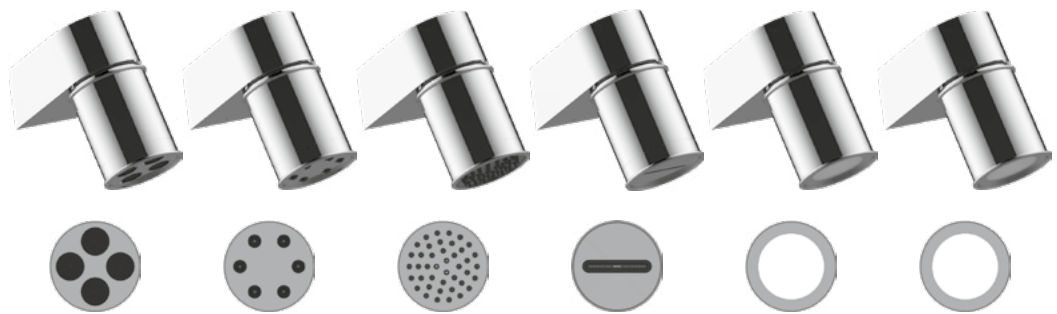

E-18201WTBP-**	E-18201WTCP-**	E-18201WTAP-**	E-18201WTGP-**	E-18201WTDP-**	E-18201WTHP-**
5746560-P-**	5746570-P-**	5746580-P-**	5746140-P-**	5746770-P-**	5746800-P-**

PC	1 067,-	1 067,-	1 067,-	1 067,-	1 720,-	2 463,-
BNi PN WT BK MBK	1 280,-	1 280,-	1 280,-	1 280,-	2 064,-	2 956,-
SN OB VBB	1 440,-	1 440,-	1 440,-	1 440,-	2 322,-	3 325,-
PB BB PG BG SG PNP BNP OX	1 600,-	1 600,-	1 600,-	1 600,-	2 580,-	3 694,-
BOX WB BB/OX PRB/BG MBK/PB	1 813,-	1 813,-	1 813,-	1 813,-	2 924,-	4 186,-
RG BRG PRB BRB GM	1 920,-	1 920,-	1 920,-	1 920,-	3 095,-	4 433,-
AU BAU						

RIVA Wall-Mount Traditional 4-Spray Showerhead • Traditional Kopfbrause mit 4 Strahlen zur Wandmontage

RIVA Wall-Mount Traditional 6-Jet Showerhead • Traditional Kopfbrause mit 6 Strahlen zur Wandmontage

RIVA Wall-Mount Traditional Showerhead • Traditional Kopfbrause zur Wandmontage

RIVA Wall-Mount Traditional Cascade Showerhead • Traditional Kopfbrause mit Wasserfall zur Wandmontage

RIVA Wall-Mount Traditional LED with Wall-Mount Button • Traditional LED-Beleuchtung zur Wandmontage

RIVA Wall-Mount Traditional LED with Wireless Remote • Traditional LED-Beleuchtung zur Wandmontage mit kabelloser Lichtsteuerung

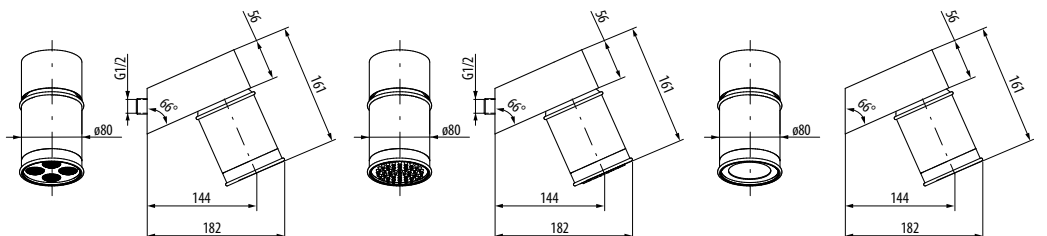

** Please specify finish • Bitte die Oberfläche auswählen

- PC
- BNi
- PN
- WT
- BK
- MBK
- SN
- OB
- VBB
- PB
- BB
- PG
- BG
- SG
- PNP
- BNP
- OX
- BOX
- WB
- BRG
- PRB
- BRB
- GM
- AU
- BAU

The Art of Shower Composition

Revealing a world of color and customization, RIVA reimagines the luxury shower.

Experience complete immersion in bespoke splendor, mesmerized by controls and components that gleam with artistry and precision and please with ease of use.

An exemplar of engineering expertise and captivating beauty, RIVA transforms the shower with unsurpassed form and function.



A person is shown from the back, showering with two rain showerheads. The showerheads are black with a silver mesh face, and they are mounted on a dark, marbled wall. The person's hands are on their head, and water is cascading over their hair and shoulders. The lighting is dramatic, highlighting the texture of the water and the person's skin.

to
maximise
your experience

The RIVA Scala Collection

**RIVA is a triumph of design
ingenuity and a celebration of the
streamlined form.**

Expressing a confident aesthetic, the sleek, cylindrical shower heads of the RIVA Scala Collection dazzle in a range of lengths and handcrafted finishes, including handsome two-tone options.

Evoking ascending notes on a musical scale, RIVA Scala inspires self-expression and joyful emotion.

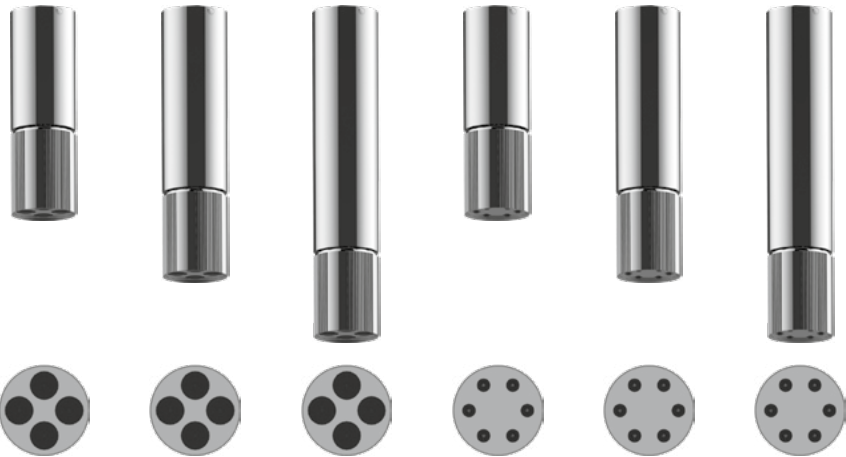
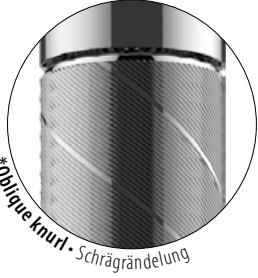
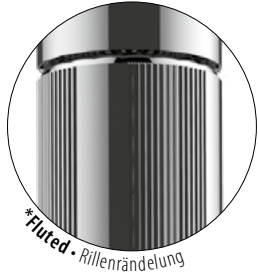

E-18210CCB*.** **E-18213CCB*.**** **E-18216CCB*.**** **E-18210CCC*.**** **E-18213CCC*.**** **E-18216CCC*.****

5745000-*.** 5745010-*.** 5745020-*.** 5745040-*.** 5745050-*.** 5745060-*.**

PC	1110,-	1219,-	1351,-	1110,-	1219,-	1351,-
BNI PN WT BK MBK	1332,-	1463,-	1621,-	1332,-	1463,-	1621,-
SN OB VBB	1499,-	1646,-	1823,-	1499,-	1646,-	1823,-
PB BB PG BG SG PNP BNP OX	1666,-	1829,-	2026,-	1666,-	1829,-	2026,-
BOX WB BB/OX PRB/BG MBK/PB	1666,-	1829,-	2026,-	1666,-	1829,-	2026,-
RG BRG PRB BRB GM	1888,-	2073,-	2296,-	1888,-	2073,-	2296,-
AU BAU	1998,-	2195,-	2432,-	1998,-	2195,-	2432,-

RIVA Scala Ceiling-Mount Contemporary 4-Spray Showerhead
25,6 cm / 33,5 cm / 41,1 cm • Contemporary Deckenkopfbrause 25,6 cm / 33,5 cm / 41,1 cm mit 4 Strahlen

RIVA Scala Ceiling-Mount Contemporary 6-Jet Showerhead
25,6 cm / 33,5 cm / 41,1 cm • Contemporary Deckenkopfbrause 25,6 cm / 33,5 cm / 41,1 cm mit 6 Strahlen

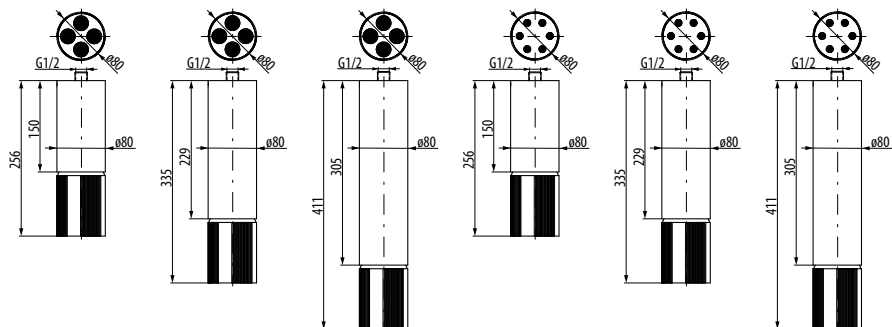

* D - Diamond knurl - Diamanträndelung / F - Fluted - Rillenrändelung / Q - Oblique knurl - Schrägrändelung / P - Smooth - Ohne Rändelung

** Please specify finish - Bitte die Oberfläche auswählen

- PC
- BNI
- PN
- WT
- BK
- MBK
- SN
- OB
- VBB
- PB
- BB
- PG
- BG
- SG
- PNP
- BNP
- OX
- BOX
- WB
- RG
- BRG
- PRB
- BRB
- GM
- AU
- BAU

Contemporary

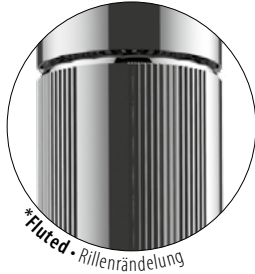

	E-18210CCA*..**	E-18213CCA*..**	E-18216CCA*..**	E-18210CCG*..**	E-18213CCG*..**	E-18216CCG*..**
	5745080..*..**	5745090..*..**	5745100..*..**	5746050..*..**	5746060..*..**	5746070..*..**
PC	1 110,-	1 219,-	1 351,-	1 110,-	1 219,-	1 351,-
BNI PN WT BK MBK	1 332,-	1 463,-	1 621,-	1 332,-	1 463,-	1 621,-
SN OB VBB	1 499,-	1 646,-	1 823,-	1 499,-	1 646,-	1 823,-
PB BB PG BG SG PNP BNP OX	1 666,-	1 829,-	2 026,-	1 666,-	1 829,-	2 026,-
BOX WB BB/OX PRB/BG MBK/PB	1 888,-	2 073,-	2 296,-	1 888,-	2 073,-	2 296,-
RG BRG PRB BRB GM	1 998,-	2 195,-	2 432,-	1 998,-	2 195,-	2 432,-
AU BAU						

RIVA Scala Ceiling-Mount Contemporary Showerhead 25,6 cm / 33,5 cm / 41,1 cm - Contemporary Deckenkopfbrause 25,6 cm / 33,5 cm / 41,1 cm

RIVA Scala Ceiling-Mount Contemporary Cascade Showerhead 25,6 cm / 33,5 cm / 41,1 cm - Contemporary Deckenkopfbrause 25,6 cm / 33,5 cm / 41,1 cm mit Wasserfall

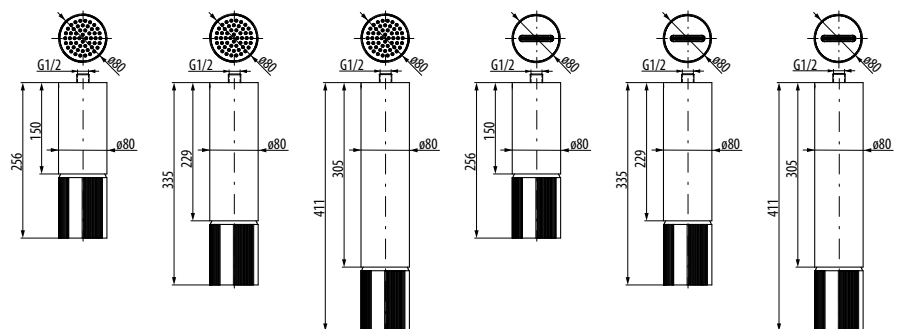

* D - Diamond knurl - Diamanträndelung / F - Fluted - Rillenrändelung / Q - Oblique knurl - Schrägrändelung / P - Smooth - Ohne Rändelung

** Please specify finish - Bitte die Oberfläche auswählen



- PC
- BNi
- PN
- WT
- BK
- MBK
- SN
- OB
- VBB
- PB
- BB
- PG
- BG
- SG
- PNP
- BNP
- OX
- BOX
- WB
- RG
- BRG
- PRB
- BRB
- GM
- AU
- BAU

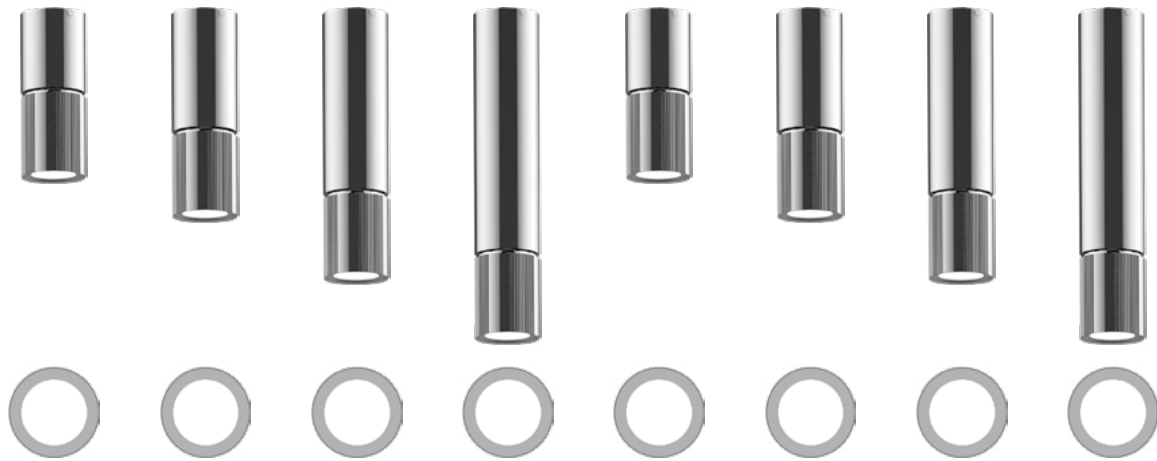

E-18208CCD*.**	E-18210CCD*.**	E-18213CCD*.**	E-18216CCD*.**	E-18208CCH*.**	E-18210CCH*.**	E-18213CCH*.**	E-18216CCH*.**
5746000-*.**	5746010-*.**	5746020-*.**	5746030-*.**	5746250-*.**	5746260-*.**	5746270-*.**	5746280-*.**
1 675,-	1 746,-	1 849,-	1 961,-	2 396,-	2 467,-	2 570,-	2 682,-
2 011,-	2 096,-	2 219,-	2 353,-	2 875,-	2 961,-	3 084,-	3 219,-
2 261,-	2 358,-	2 496,-	2 648,-	3 235,-	3 331,-	3 469,-	3 622,-
2 512,-	2 619,-	2 773,-	2 942,-	3 594,-	3 701,-	3 854,-	4 023,-
2 848,-	2 969,-	3 142,-	3 334,-	4 074,-	4 195,-	4 368,-	4 560,-
3 015,-	3 143,-	3 327,-	3 530,-	4 313,-	4 441,-	4 626,-	4 828,-

RIVA Scala Ceiling-Mount Contemporary LED with Wall-Mount Button 20,6 cm / 25,6 cm / 33,5 cm / 41,1 cm • Contemporary Decken-LED-Beleuchtung 20,6 cm / 25,6 cm / 33,5 cm / 41,1 cm

RIVA Scala Ceiling-Mount Contemporary LED with Wireless Remote 20,6 cm / 25,6 cm / 33,5 cm / 41,1 cm • Contemporary Decken-LED-Beleuchtung 20,6 cm / 25,6 cm / 33,5 cm / 41,1 cm mit kabelloser Lichtsteuerung

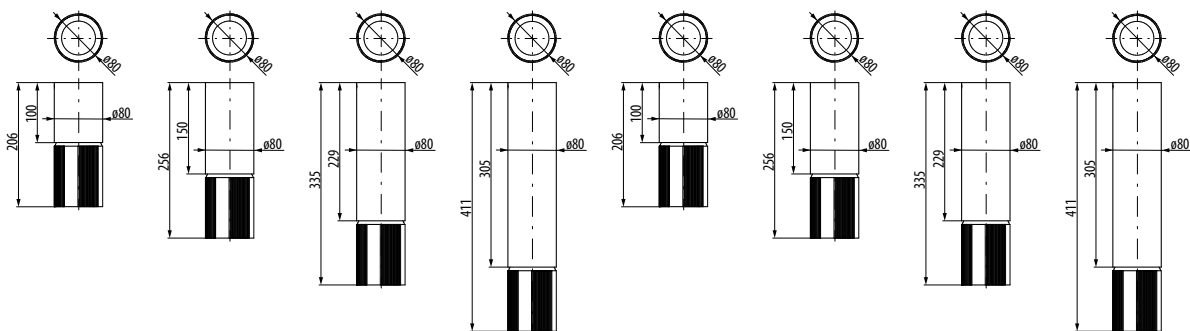

* D - Diamond knurl • Diamanträndelung / F - Fluted • Rillenrändelung / Q - Oblique knurl • Schrägrändelung / P - Smooth • Ohne Rändelung

** Please specify finish • Bitte die Oberfläche auswählen



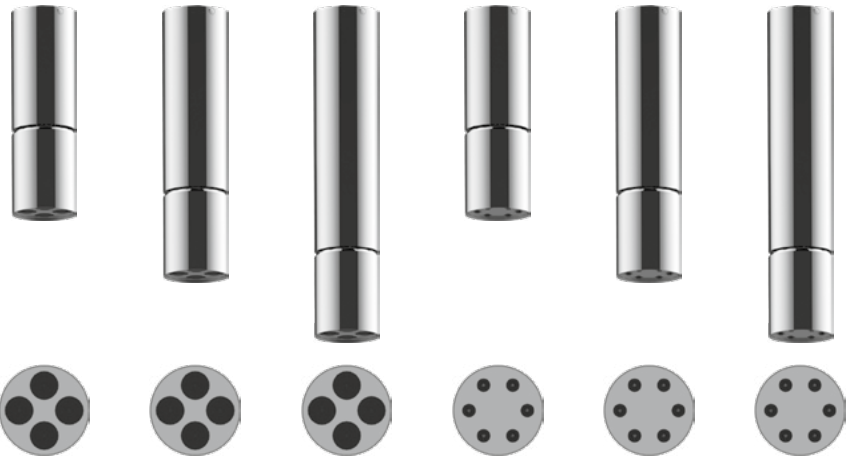

E-18210CCBP-** **E-18213CCBP-**** **E-18216CCBP-**** **E-18210CCCP-**** **E-18213CCCP-**** **E-18216CCCP-****

5745000-P-** 5745010-P-** 5745020-P-** 5745040-P-** 5745050-P-** 5745060-P-**

PC	1 030,-	1 139,-	1 270,-	1 030,-	1 139,-	1 270,-
BNI PN WT BK MBK	1 236,-	1 367,-	1 524,-	1 236,-	1 367,-	1 524,-
SN OB VBB	1 391,-	1 538,-	1 715,-	1 391,-	1 538,-	1 715,-
PB BB PG BG SG PNP BNP OX	1 545,-	1 708,-	1 905,-	1 545,-	1 708,-	1 905,-
BOX WB BB/OX PRB/BG MBK/PB	1 751,-	1 936,-	2 159,-	1 751,-	1 936,-	2 159,-
RG BRG PRB BRB GM	1 853,-	2 050,-	2 287,-	1 853,-	2 050,-	2 287,-
AU BAU						

RIVA Scala Ceiling-Mount Contemporary 4-Spray Showerhead
25,6 cm / 33,5 cm / 41,1 cm • Contemporary Deckenkopfbrause 25,6 cm / 33,5 cm / 41,1 cm mit 4 Strahlen

RIVA Scala Ceiling-Mount Contemporary 6-Jet Showerhead
25,6 cm / 33,5 cm / 41,1 cm • Contemporary Deckenkopfbrause 25,6 cm / 33,5 cm / 41,1 cm mit 6 Strahlen

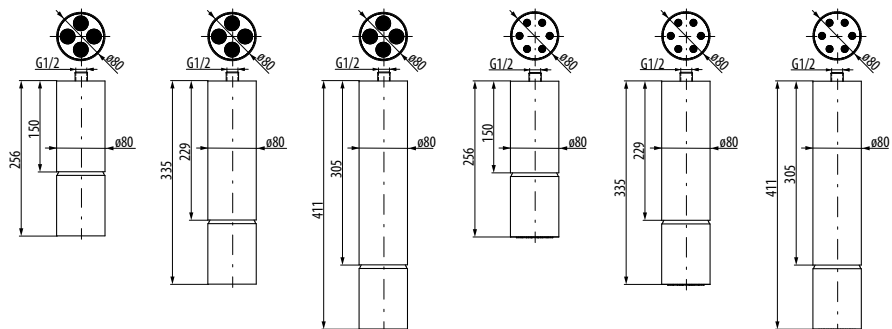

** Please specify finish • Bitte die Oberfläche auswählen

- PC
- BNI
- PN
- WT
- BK
- MBK
- SN
- OB
- VBB
- PB
- BB
- PG
- BG
- SG
- PNP
- BNP
- OX
- BOX
- WB
- RG
- BRG
- PRB
- BRB
- GM
- AU
- BAU

Contemporary

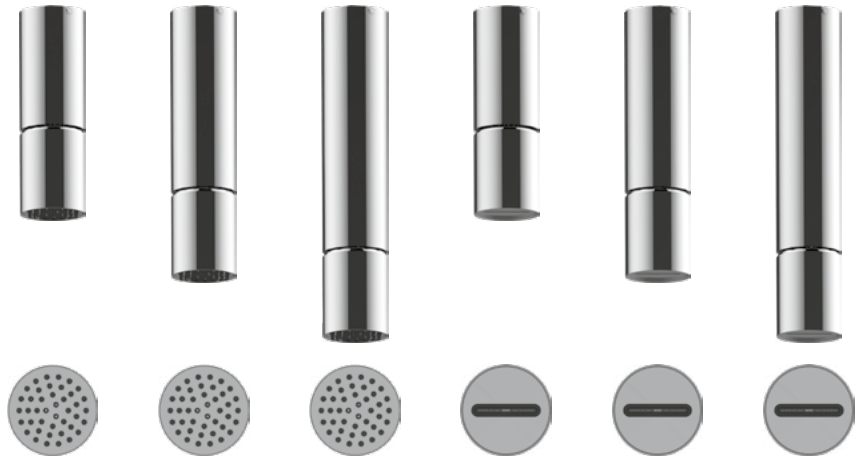

	E-18210CCAP-**	E-18213CCAP-**	E-18216CCAP-**	E-18210CCGP-**	E-18213CCGP-**	E-18216CCGP-**
	5745080-P-**	5745090-P-**	5745100-P-**	5746050-P-**	5746060-P-**	5746070-P-**
PC	1 030,-	1 139,-	1 270,-	1 030,-	1 139,-	1 270,-
BNi PN WT BK MBK	1 236,-	1 367,-	1 524,-	1 236,-	1 367,-	1 524,-
SN OB VBB	1 391,-	1 538,-	1 715,-	1 391,-	1 538,-	1 715,-
PB BB PG BG SG PNP BNP OX	1 545,-	1 708,-	1 905,-	1 545,-	1 708,-	1 905,-
BOX WB BB/OX PRB/BG MBK/PB	1 751,-	1 936,-	2 159,-	1 751,-	1 936,-	2 159,-
RG BRG PRB BRB GM	1 751,-	1 936,-	2 159,-	1 751,-	1 936,-	2 159,-
AU BAU	1 853,-	2 050,-	2 287,-	1 853,-	2 050,-	2 287,-

RIVA Scala Ceiling-Mount Contemporary Showerhead 25,6 cm / 33,5 cm / 41,1 cm - Contemporary Deckenkopfbrause 25,6 cm / 33,5 cm / 41,1 cm

RIVA Scala Ceiling-Mount Contemporary Cascade Showerhead 25,6 cm / 33,5 cm / 41,1 cm - Contemporary Deckenkopfbrause 25,6 cm / 33,5 cm / 41,1 cm mit Wasserfall

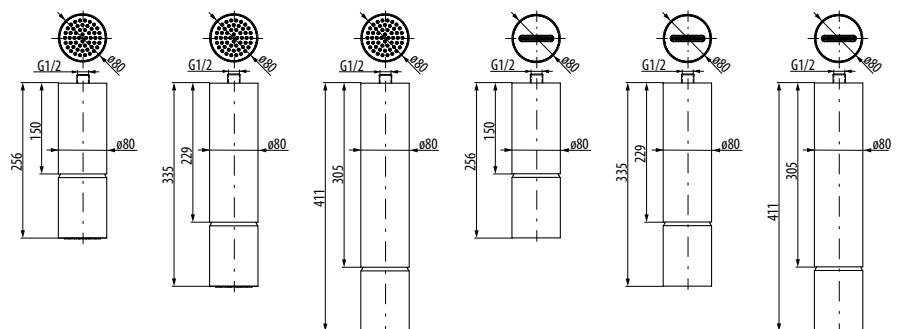

** Please specify finish - Bitte die Oberfläche auswählen



- PC
- BNi
- PN
- WT
- BK
- MBK
- SN
- OB
- VBB
- PB
- BB
- PG
- BG
- SG
- PNP
- BNP
- OX
- BOX
- WB
- RG
- BRG
- PRB
- BRB
- GM
- AU
- BAU

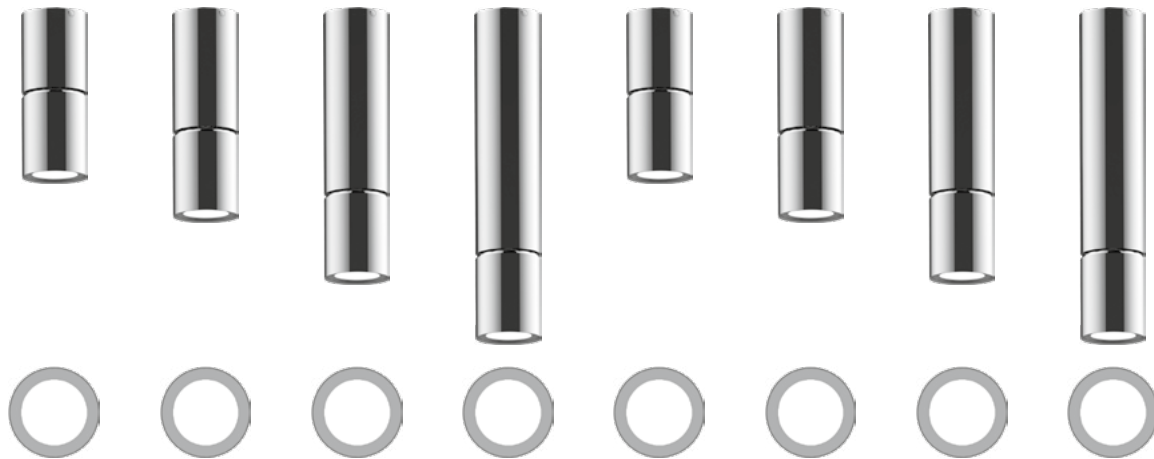

E-18208CCDP-**	E-18210CCDP-**	E-18213CCDP-**	E-18216CCDP-**	E-18208CCHP-**	E-18210CCHP-**	E-18213CCHP-**	E-18216CCHP-**
5746000-P-**	5746010-P-**	5746020-P-**	5746030-P-**	5746250-P-**	5746260-P-**	5746270-P-**	5746280-P-**
1 596,-	1 667,-	1 769,-	1 882,-	2 317,-	2 388,-	2 490,-	2 603,-
1 915,-	2 000,-	2 123,-	2 259,-	2 780,-	2 866,-	2 988,-	3 124,-
2 154,-	2 251,-	2 389,-	2 541,-	3 127,-	3 224,-	3 362,-	3 515,-
2 394,-	2 501,-	2 654,-	2 823,-	3 475,-	3 582,-	3 736,-	3 905,-
2 712,-	2 834,-	3 008,-	3 200,-	3 938,-	4 060,-	4 234,-	4 426,-
2 872,-	3 001,-	3 185,-	3 387,-	4 170,-	4 298,-	4 482,-	4 686,-

RIVA Scala Ceiling-Mount Contemporary LED with Wall-Mount Button 20,6 cm / 25,6 cm / 33,5 cm / 41,1 cm • Contemporary Decken-LED-Beleuchtung 20,6 cm / 25,6 cm / 33,5 cm / 41,1 cm

RIVA Scala Ceiling-Mount Contemporary LED with Wireless Remote 20,6 cm / 25,6 cm / 33,5 cm / 41,1 cm • Contemporary Decken-LED-Beleuchtung 20,6 cm / 25,6 cm / 33,5 cm / 41,1 cm mit kabelloser Lichtsteuerung

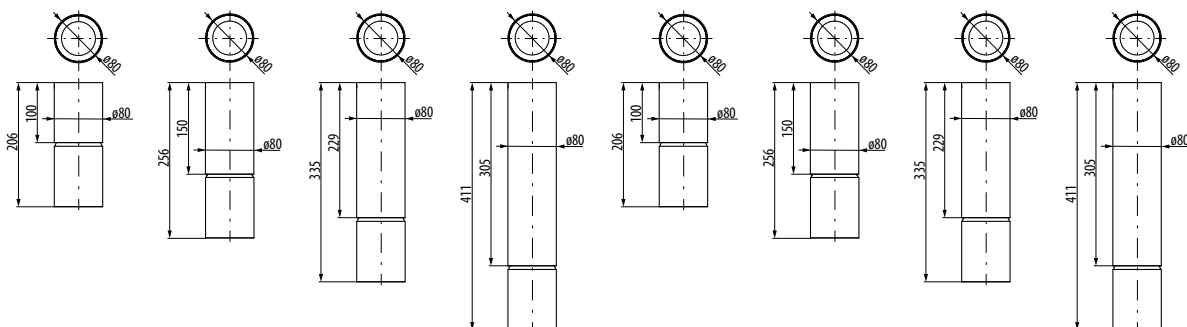

** Please specify finish • Bitte die Oberfläche auswählen

Bold Luxury

A passion for bold modern design is realized in the RIVA Scala Collection.

Crafted from durable materials of the highest caliber, RIVA Scala is designed for enduring aesthetics and peerless performance.

Presenting luxurious jet, spray, and cascade options, RIVA Scala transforms daily ritual into an indulgent spa experience.



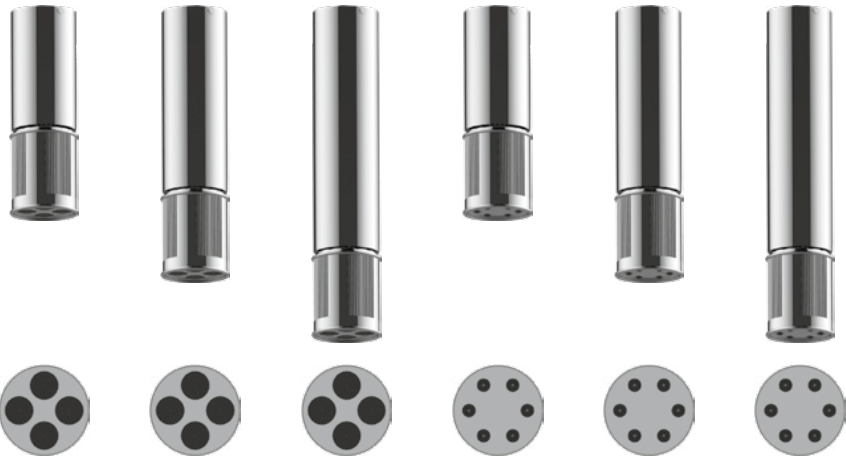
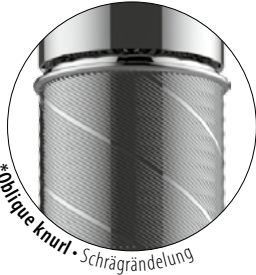
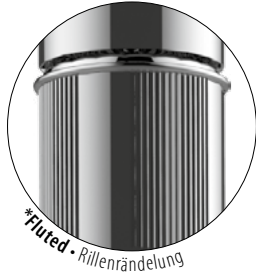

E-18210CTB E-18213CTB** E-18216CTB** E-18210CTC** E-18213CTC** E-18216CTC****

5745500-*.** 5745510-*.** 5745520-*.** 5745540-*.** 5745550-*.** 5745560-*.**

PC	1 216,-	1 326,-	1 456,-	1 216,-	1 326,-	1 456,-
BNi PN WT BK MBK	1 460,-	1 592,-	1 748,-	1 460,-	1 592,-	1 748,-
SN OB VBB	1 642,-	1 791,-	1 967,-	1 642,-	1 791,-	1 967,-
PB BB PG BG SG PNP BNP OX	1 824,-	1 990,-	2 184,-	1 824,-	1 990,-	2 184,-
BOX WB BB/OX PRB/BG MBK/PB						
RG BRG PRB BRB GM	2 067,-	2 256,-	2 476,-	2 067,-	2 256,-	2 476,-
AU BAU	2 189,-	2 388,-	2 621,-	2 189,-	2 388,-	2 621,-

RIVA Scala Ceiling-Mount Traditional 4-Spray Showerhead
25,6 cm / 33,5 cm / 41,1 cm • Traditional Deckenkopfbrause 25,6 cm / 33,5 cm / 41,1 cm mit 4 Strahlen

RIVA Scala Ceiling-Mount Traditional 6-Jet Showerhead 25,6 cm / 33,5 cm / 41,1 cm • Traditional Deckenkopfbrause 25,6 cm / 33,5 cm / 41,1 cm mit 6 Strahlen

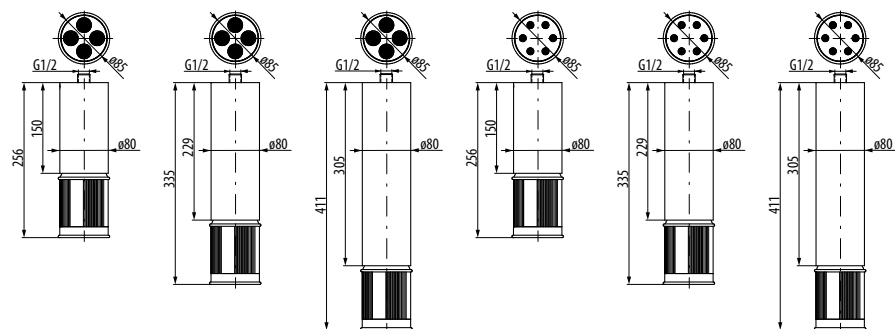

* D - Diamond knurl - Diamanträndelung / F - Fluted - Rillenrändelung / Q - Oblique knurl - Schrägrändelung / P - Smooth - Ohne Rändelung

** Please specify finish - Bitte die Oberfläche auswählen

- PC
- BNi
- PN
- WT
- BK
- MBK
- SN
- OB
- VBB
- PB
- BB
- PG
- BG
- SG
- PNP
- BNP
- OX
- BOX
- WB
- RG
- BRG
- PRB
- BRB
- GM
- AU
- BAU

Traditional



*Diamond knurl - Diamanträndelung



*Fluted - Rillenrändelung

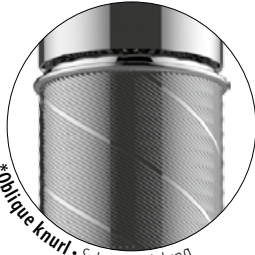

*Oblique knurl - Schrägrändelung

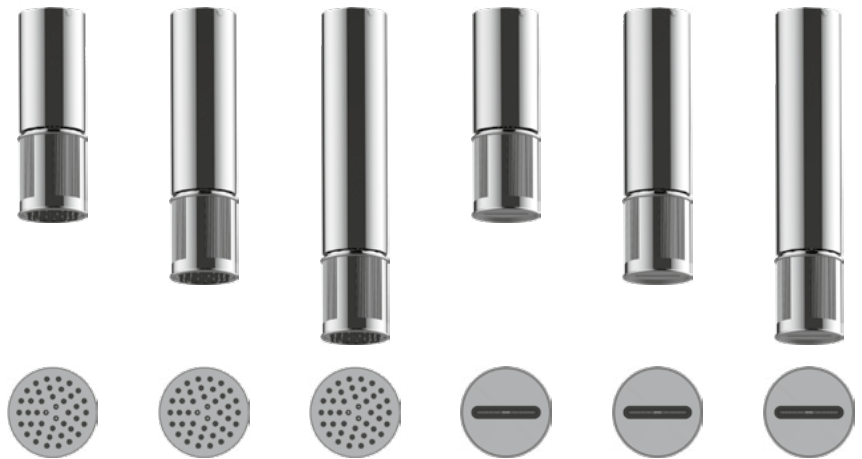

	E-18210CTA*..**	E-18213CTA*..**	E-18216CTA*..**	E-18210CTG*..**	E-18213CTG*..**	E-18216CTG*..**
	5745580-*.**	5745590-*.**	5745600-*.**	5746090-*.**	5746100-*.**	5746110-*.**
PC	1 216,-	1 326,-	1 456,-	1 216,-	1 326,-	1 456,-
BNI PN WT BK MBK	1 460,-	1 592,-	1 748,-	1 460,-	1 592,-	1 748,-
SN OB VBB	1 642,-	1 791,-	1 967,-	1 642,-	1 791,-	1 967,-
PB BB PG BG SG PNP BNP OX	1 824,-	1 990,-	2 184,-	1 824,-	1 990,-	2 184,-
BOX WB BB/OX PRB/BG MBK/PB						
RG BRG PRB BRB GM	2 067,-	2 256,-	2 476,-	2 067,-	2 256,-	2 476,-
AU BAU	2 189,-	2 388,-	2 621,-	2 189,-	2 388,-	2 621,-

RIVA Scala Ceiling-Mount Traditional Showerhead 25,6 cm / 33,5 cm / 41,1 cm • Traditional Deckenkopfbrause 25,6 cm / 33,5 cm / 41,1 cm

RIVA Scala Ceiling-Mount Traditional Cascade Showerhead 25,6 cm / 33,5 cm / 41,1 cm • Traditional Deckenkopfbrause 25,6 cm / 33,5 cm / 41,1 cm mit Wasserfall

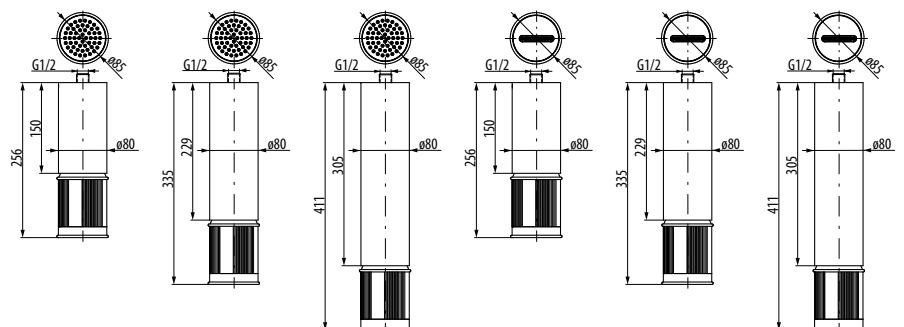

* D - Diamond knurl - Diamanträndelung / F - Fluted - Rillenrändelung / Q - Oblique knurl - Schrägrändelung / P - Smooth - Ohne Rändelung

** Please specify finish - Bitte die Oberfläche auswählen



- PC
- BNi
- PN
- WT
- BK
- MBK
- SN
- OB
- VBB
- PB
- BB
- PG
- BG
- SG
- PNP
- BNP
- OX
- BOX
- WB
- RG
- BRG
- PRB
- BRB
- GM
- AU
- BAU

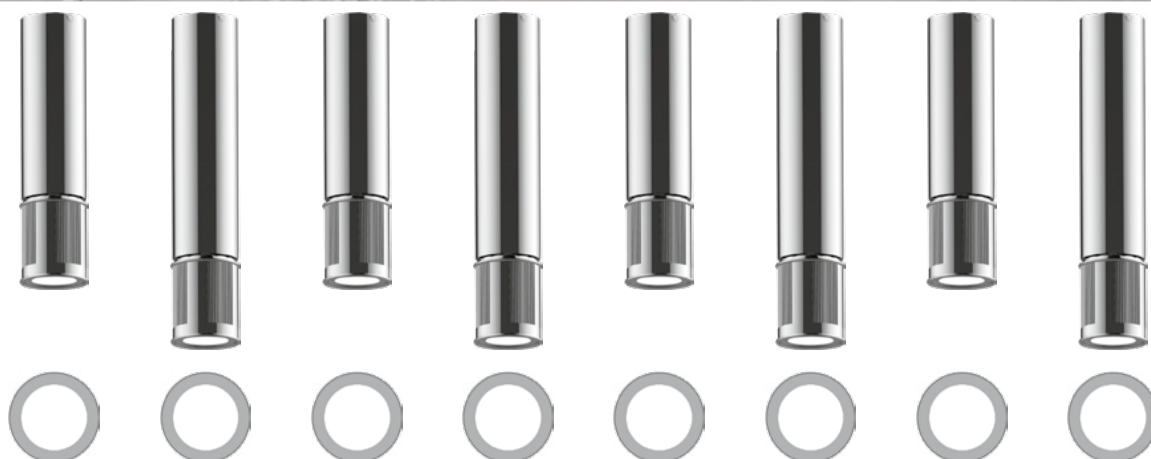

E-18208CTD*.**	E-18210CTD*.**	E-18213CTD*.**	E-18216CTD*.**	E-18208CTH*.**	E-18210CTH*.**	E-18213CTH*.**	E-18216CTH*.**
5746200-*.**	5746210-*.**	5746220-*.**	5746230-*.**	5746300-*.**	5746310-*.**	5746320-*.**	5746330-*.**
1 765,-	1 847,-	1 949,-	2 062,-	2 486,-	2 568,-	2 670,-	2 783,-
2 118,-	2 218,-	2 338,-	2 475,-	2 984,-	3 082,-	3 204,-	3 340,-
2 382,-	2 495,-	2 631,-	2 785,-	3 356,-	3 468,-	3 605,-	3 758,-
2 647,-	2 771,-	2 923,-	3 094,-	3 729,-	3 853,-	4 005,-	4 175,-
3 000,-	3 141,-	3 312,-	3 507,-	4 226,-	4 367,-	4 538,-	4 732,-
3 177,-	3 325,-	3 508,-	3 713,-	4 474,-	4 623,-	4 805,-	5 010,-

RIVA Scala Ceiling-Mount Traditional LED with Wall-Mount Button 20,6 cm / 25,6 cm / 33,5 cm / 41,1 cm • Traditional Decken-LED-Beleuchtung 20,6 cm / 25,6 cm / 33,5 cm / 41,1 cm

RIVA Scala Ceiling-Mount Traditional LED with Wireless Remote 20,6 cm / 25,6 cm / 33,5 cm / 41,1 cm • Traditional Decken-LED-Beleuchtung 20,6 cm / 25,6 cm / 33,5 cm / 41,1 cm mit kabelloser Lichtsteuerung

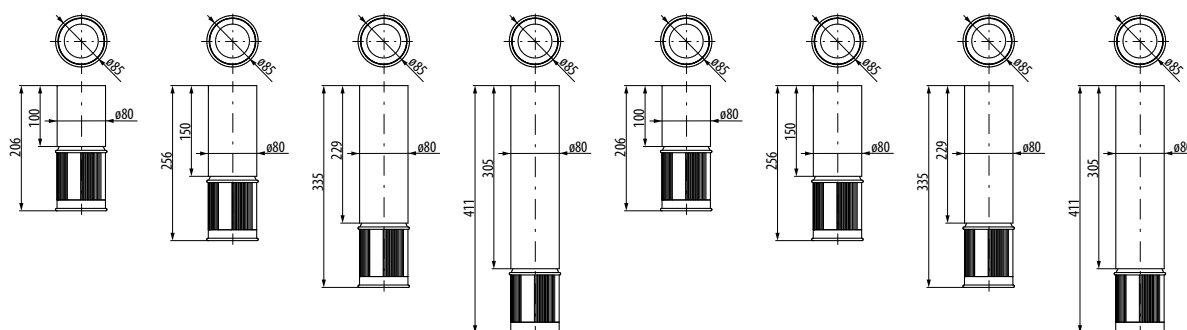

* D - Diamond knurl • Diamanträndelung / F - Fluted • Rillenrändelung / Q - Oblique knurl • Schrägrändelung / P - Smooth • Ohne Rändelung

** Please specify finish • Bitte die Oberfläche auswählen

Traditionnal



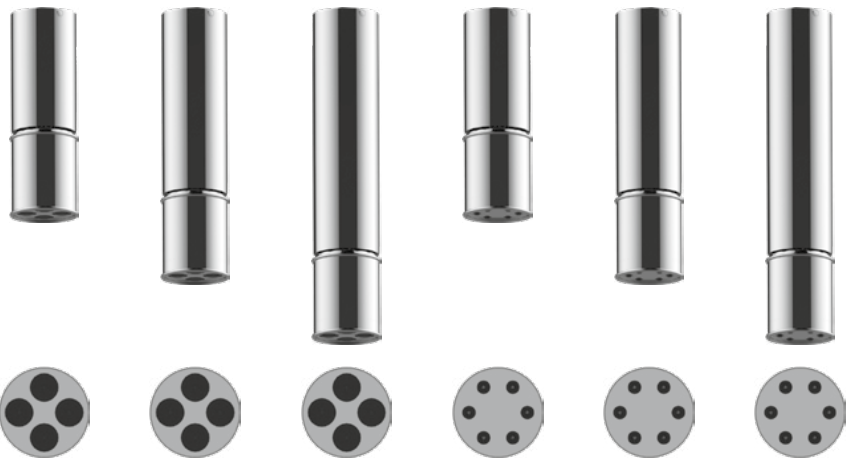

E-18210CTBP-** **E-18213CTBP-**** **E-18216CTBP-**** **E-18210CTCP-**** **E-18213CTCP-**** **E-18216CTCP-****

5745500-P-** 5745510-P-** 5745520-P-** 5745540-P-** 5745550-P-** 5745560-P-**

PC	1136,-	1246,-	1376,-	1136,-	1246,-	1376,-
BNi PN WT BK MBK	1363,-	1495,-	1652,-	1363,-	1495,-	1652,-
SN OB VBB	1533,-	1683,-	1858,-	1533,-	1683,-	1858,-
PB BB PG BG SG PNP BNP OX	1704,-	1869,-	2064,-	1704,-	1869,-	2064,-
BOX WB BB/OX PRB/BG MBK/PB	1930,-	2119,-	2340,-	1930,-	2119,-	2340,-
RG BRG PRB BRB GM	2044,-	2243,-	2476,-	2044,-	2243,-	2476,-
AU BAU						

RIVA Scala Ceiling-Mount Traditional 4-Spray Showerhead
 25,6 cm / 33,5 cm / 41,1 cm • Traditional Deckenkopfbrause 25,6 cm / 33,5 cm / 41,1 cm mit 4 Strahlen

RIVA Scala Ceiling-Mount Traditional 6-Jet Showerhead 25,6 cm / 33,5 cm / 41,1 cm • Traditional Deckenkopfbrause 25,6 cm / 33,5 cm / 41,1 cm mit 6 Strahlen

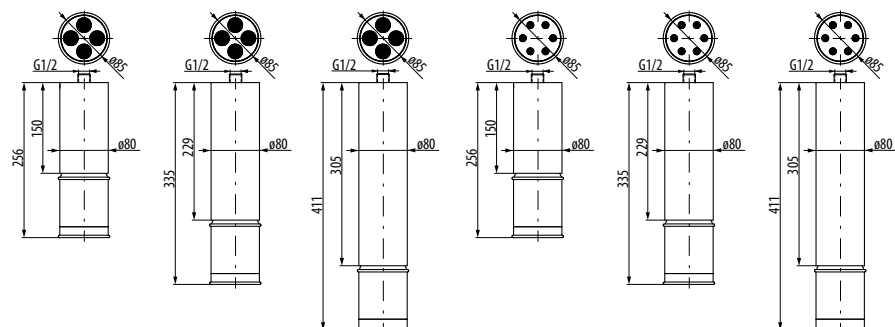

** Please specify finish • Bitte die Oberfläche auswählen

- PC
- BNi
- PN
- WT
- BK
- MBK
- SN
- OB
- VBB
- PB
- BB
- PG
- BG
- SG
- PNP
- BNP
- OX
- BOX
- WB
- RG
- BRG
- PRB
- BRB
- GM
- AU
- BAU

Traditional



	E-18210CTAP-**	E-18213CTAP-**	E-18216CTAP-**	E-18210CTGP-**	E-18213CTGP-**	E-18216CTGP-**
	5745580-P-**	5745590-P-**	5745600-P-**	5746090-P-**	5746100-P-**	5746110-P-**
PC	1 136,-	1 246,-	1 376,-	1 136,-	1 246,-	1 376,-
BNi PN WT BK MBK	1 363,-	1 495,-	1 652,-	1 363,-	1 495,-	1 652,-
SN OB VBB	1 533,-	1 683,-	1 858,-	1 533,-	1 683,-	1 858,-
PB BB PG BG SG PNP BNP OX	1 704,-	1 869,-	2 064,-	1 704,-	1 869,-	2 064,-
BOX WB BB/OX PRB/BG MBK/PB						
RG BRG PRB BRB GM	1 930,-	2 119,-	2 340,-	1 930,-	2 119,-	2 340,-
AU BAU	2 044,-	2 243,-	2 476,-	2 044,-	2 243,-	2 476,-

RIVA Scala Ceiling-Mount Traditional Showerhead 25,6 cm / 33,5 cm / 41,1 cm • Traditional Deckenkopfbrause 25,6 cm / 33,5 cm / 41,1 cm

RIVA Scala Ceiling-Mount Traditional Cascade Showerhead 25,6 cm / 33,5 cm / 41,1 cm • Traditional Deckenkopfbrause 25,6 cm / 33,5 cm / 41,1 cm mit Wasserfall

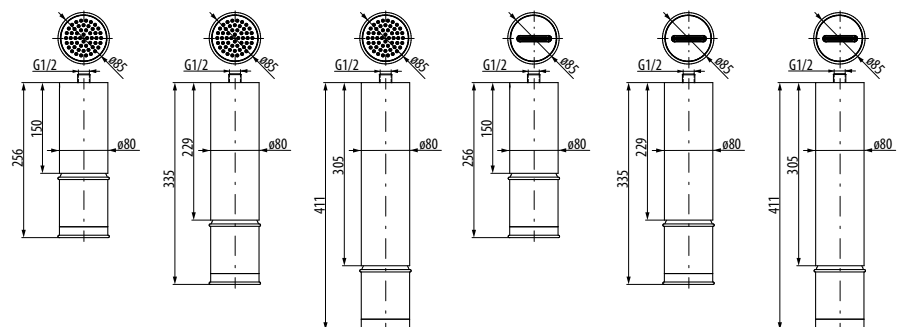

** Please specify finish • Bitte die Oberfläche auswählen

- PC
- BNi
- PN
- WT
- BK
- MBK
- SN
- OB
- VBB
- PB
- BB
- PG
- BG
- SG
- PNP
- BNP
- OX
- BOX
- WB
- RG
- BRG
- PRB
- BRB
- GM
- AU
- BAU

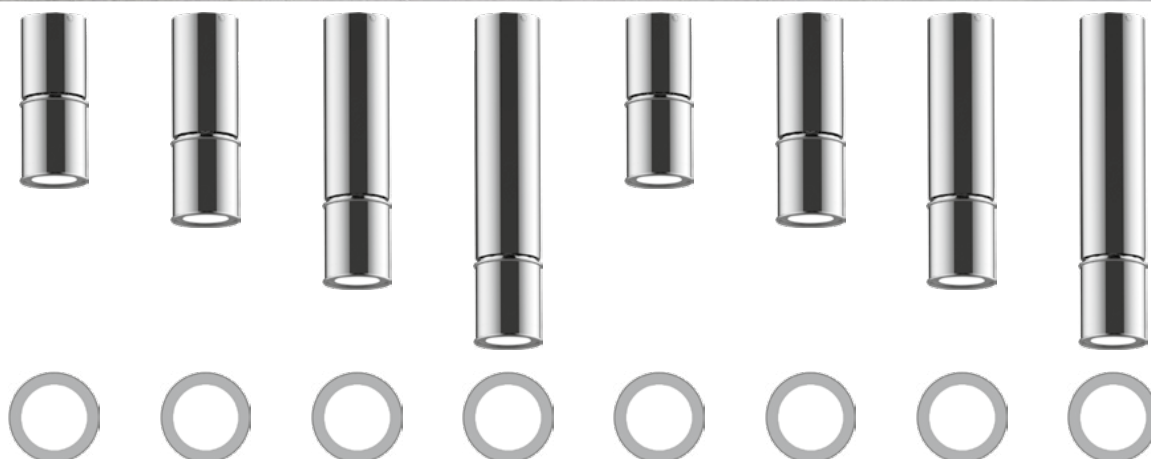

E-18208CTDP-**	E-18210CTDP-**	E-18213CTDP-**	E-18216CTDP-**	E-18208CTHP-**	E-18210CTHP-**	E-18213CTHP-**	E-18216CTHP-**
5746200-P-**	5746210-P-**	5746220-P-**	5746230-P-**	5746300-P-**	5746310-P-**	5746320-P-**	5746330-P-**
1 685,-	1 768,-	1 869,-	1 983,-	2 406,-	2 489,-	2 590,-	2 704,-
2 022,-	2 122,-	2 243,-	2 380,-	2 888,-	2 987,-	3 109,-	3 246,-
2 275,-	2 387,-	2 524,-	2 678,-	3 249,-	3 361,-	3 498,-	3 651,-
2 528,-	2 652,-	2 804,-	2 974,-	3 609,-	3 733,-	3 885,-	4 057,-
2 865,-	3 005,-	3 178,-	3 371,-	4 091,-	4 231,-	4 404,-	4 597,-
3 033,-	3 183,-	3 364,-	3 570,-	4 331,-	4 481,-	4 663,-	4 867,-

RIVA Scala Ceiling-Mount Traditional LED with Wall-Mount Button 20,6 cm / 25,6 cm / 33,5 cm / 41,1 cm • Traditional Decken-LED-Beleuchtung 20,6 cm / 25,6 cm / 33,5 cm / 41,1 cm

RIVA Scala Ceiling-Mount Traditional LED with Wireless Remote 20,6 cm / 25,6 cm / 33,5 cm / 41,1 cm • Traditional Decken-LED-Beleuchtung 20,6 cm / 25,6 cm / 33,5 cm / 41,1 cm mit kabelloser Lichtsteuerung

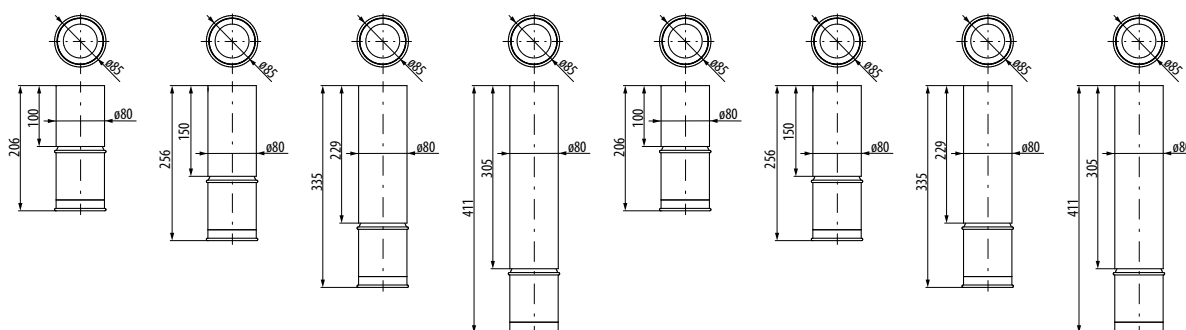

** Please specify finish • Bitte die Oberfläche auswählen



The RIVA Chandelier Collection

An enchanting masterpiece of smooth, slender beacons in precious metal finishes, the RIVA Chandelier Collection adorns the bath space with clean contours of warm, modern glamour.

The RIVA Chandelier Collection offers components with fluted, diamond, and oblique knurling and a range of matching accessories for a flawless aesthetic of contemporary elegance.

Luxurious texture and finish choices express personal style, supported by durable materials, expert engineering, and leading-edge technology.



E-18203SCIP-**

5783020-P-**



E-18202SCAP-**

5783000-P-**



PC				
BNi	PN	WT	BK	MBK
SN		OB	VBB	
PB	BB	PG	BG	SG
PNP	BNP	OX	BOX	WB
RG	BRG	PRB	BRB	GM
AU		BAU		

771,-
925,-
1 041,-
1 156,-
1 310,-
1 387,-

549,-
659,-
741,-
824,-
933,-
988,-

Wall mounted slim shower head and cascade • Slim Kopfbrause mit Wasserfall zur Wandmontage

Wall mounted slim shower head • Slim Kopfbrause zur Wandmontage

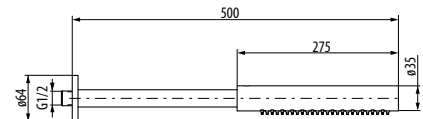
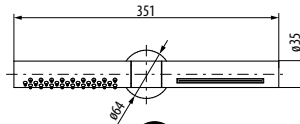

E-18203R

5783030



118,-

Rough for E-18203SCIP-** • UP-Teil zu Slim Kopfbrause



Available from the third quarter of 2025
Verfügbar ab dem dritten Quartal 2025

** Please specify finish • Bitte die Oberfläche auswählen

- PC
- BNi
- PN
- WT
- BK
- MBK
- SN
- OB
- VBB
- PB
- BB
- PG
- BG
- SG
- PNP
- BNP
- OX
- BOX
- WB
- RG
- BRG
- PRB
- BRB
- GM
- AU
- BAU

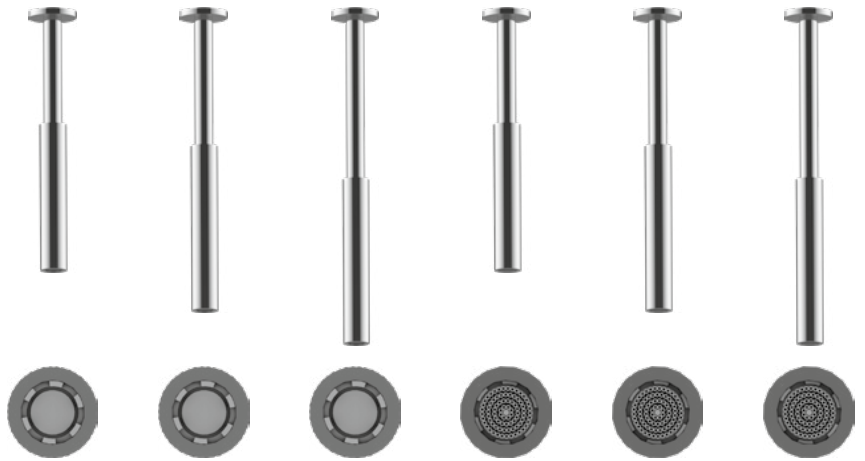
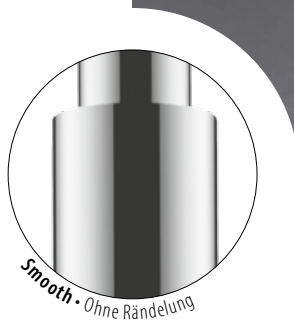

E-18214SCFP-** **E-18216SCFP-**** **E-18218SCFP-**** **E-18214SCEP-**** **E-18216SCEP-**** **E-18218SCEP-****
 5746910-P-** 5746950-P-** 5746960-P-** 5746940-P-** 5746920-P-** 5746930-P-**

PC	409,-	459,-	466,-	409,-	459,-	466,-
BNi PN WT BK MBK	490,-	551,-	559,-	490,-	551,-	559,-
SN OB VBB	552,-	620,-	630,-	552,-	620,-	630,-
PB BB PG BG SG PNP BNP OX	613,-	689,-	700,-	613,-	689,-	700,-
BOX WB BB/OX PRB/BG MBK/PB	695,-	781,-	793,-	695,-	781,-	793,-
RG BRG PRB BRB GM	735,-	827,-	839,-	735,-	827,-	839,-
AU BAU						

RIVA Chandelier Contemporary Laminar Showerhead 35,5 cm / 41 cm / 45,5 cm - Contemporary Kopfbrause 35,5 cm / 41 cm / 45,5 cm mit Laminarstrahl

RIVA Chandelier Contemporary Spray Showerhead 35,5 cm / 41 cm / 45,5 cm - Contemporary Kopfbrause 35,5 cm / 41 cm / 45,5 cm mit Regenstrahl

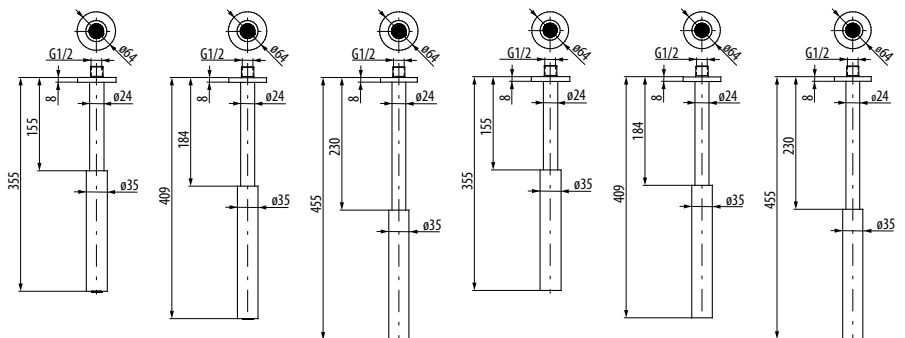

** Please specify finish - Bitte die Oberfläche auswählen

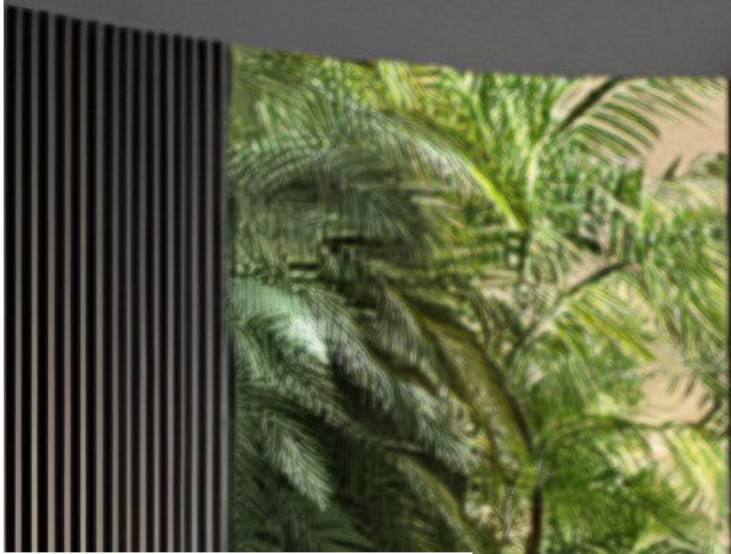

E-18210SDP-**

E-18210SCHP-**

5746900-P-**

5746890-P-**

1 056,-

1 628,-

1 268,-

1 953,-

1 426,-

2 198,-

1 584,-

2 442,-

1 796,-

2 767,-

1 901,-

2 930,-

RIVA Chandelier
Contempo-rary LED with
Wall-Mount Button 25,5 cm
• Contemporary LED-Beleuchtung
25,5 cm

RIVA Chandelier
Contempora-ry LED with
Wireless Remote 25,5 cm ·
Contemporary LED-Be-leuchtung
25,5 cm mit kabelloser
Lichtsteuerung

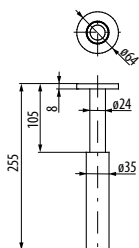
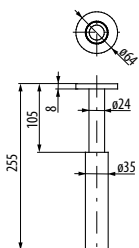

** Please specify finish - Bitte die Oberfläche auswählen

Showerhead Flow Rates



Flow Rates (l/min) • Durchflussraten (l/min)							
CODE	MODEL • MODELL	PRESSURE • DRUCK					
		1 bar	2 bar	3 bar	4 bar	5 bar	
E-18210CCB*	RIVA Scala Ceiling-Mount Contemporary / Traditional 4-Spray Showerhead • Contemporary / Traditional Deckenkopfbrause mit 4 Strahlen	9	12	14	14	15	
E-18213CCB*							
E-18216CCB*							
E-18210CTB*							
E-18213CTB*							
E-18216CTB*							
E-18201WCB*	RIVA Wall-Mount Contemporary / Traditional 4-Spray Showerhead • Contemporary / Traditional Kopfbrause mit 4 Strahlen zur Wandmontage	8	12	14	15	15	
E-18201WTB*							
E-18210CCA*	RIVA Scala Ceiling-Mount Contemporary / Traditional Showerhead • Contemporary / Traditional Deckenkopfbrause	10	13	15	15	15	
E-18213CCA*							
E-18216CCA*							
E-18210CTA*							
E-18213CTA*							
E-18216CTA*							
E-18201WCA*	RIVA Wall-Mount Contemporary / Traditional Showerhead • Contemporary / Traditional Kopfbrause zur Wandmontage	9	12	14	14	15	
E-18201WTA*							
E-18210CCC*	RIVA Scala Ceiling-Mount Contemporary / Traditional 6-Jet Showerhead • Contemporary / Traditional Deckenkopfbrause mit 6 Strahlen	6	9	10	12	13	
E-18213CCC*							
E-18216CCC*							
E-18210CTC*							
E-18213CTC*							
E-18216CTC*							
E-18201WCC*	RIVA Wall-Mount Contemporary / Traditional 6-Jet Showerhead • Contemporary / Traditional Kopfbrause mit 6 Strahlen zur Wandmontage	6	8	10	12	13	
E-18201WTC*							
E-18210CCG*	RIVA Scala Ceiling-Mount Contemporary / Traditional Cascade Showerhead • Contemporary / Traditional Deckenkopfbrause mit Wasserfall	10	13	14	15	15	
E-18213CCG*							
E-18216CCG*							
E-18210CTG*							
E-18213CTG*							
E-18216CTG*							
E-18201WCG*	RIVA Wall-Mount Contemporary / Traditional Cascade Showerhead • Contemporary / Traditional Kopfbrause mit Wasserfall zur Wandmontage	9	13	15	15	15	
E-18201WTC*							
E-18214SCEP	RIVA Chandelier Contemporary Spray Shower-head • Contemporary Kopfbrause mit Regenstrahl	5	6	6	6	7	
E-18216SCEP							
E-18218SCEP							
E-18214SCFP	RIVA Chandelier Contemporary Laminar Shower-head • Contemporary Kopfbrause mit Laminarstrahl	8	11	14	16	18	
E-18216SCFP							
E-18218SCFP							
E-18203SCIP	Wall mounted slim shower head ① and cascade ② • Slim Kopfbrause ① mit Wasserfall ② zur Wandmontage	①	6,3	9,5	12,2	14,0	14,5
		②	7,3	10,7	13,6	15,3	15,0
E-18202SCAP	Wall mounted slim shower head • Slim Kopfbrause zur Wandmontage	7,5	11,1	14,2	16,0	15,1	

* D - Diamond knurl • Diamanträndelung / F - Fluted • Rillenträndelung / Q - Oblique knurl • Schrägrändelung / P - Smooth • Ohne Rändelung



INSPIRED BY
DASHBOARDS OF

LUXURY CARS AND





YACHTS





RIVA Trims

Precision Instruments, Positioned with Perfection

A stunning contemporary sculpture, the RIVA shower's levers and controls suggest the instrument panels of glamorous sports cars and elegant yachts.

Exhilarating design, unmatched attention to detail, and advanced engineering distinguish RIVA within the highest tiers of luxury.

A testament to superior craftsmanship and quality, RIVA is designed to thrill and soothe body and soul.





*Diamond knurl - Diamanträndelung

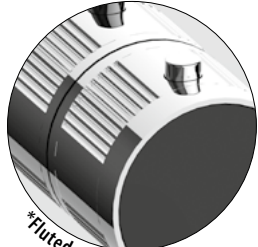

*Fluted - Rillenrändelung

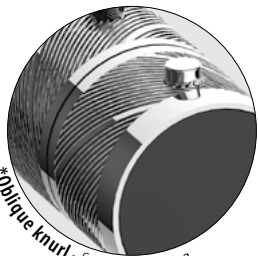

*Oblique knurl - Schrägrändelung

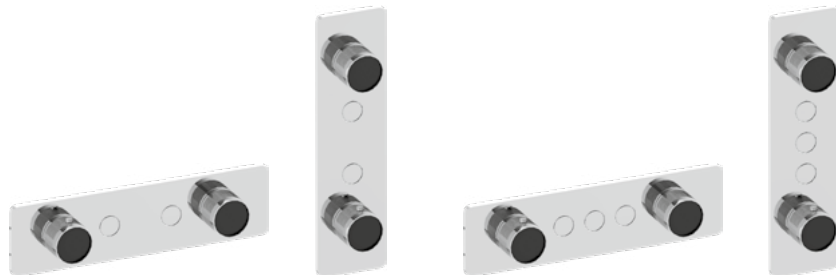

E-18022HA*.- -T** **E-18022VA*.-** -T** **E-18023HA*.-** -T** **E-18023VA*.-** -T**

5739550*.-** 5739750*.-** 5739540*.-** 5739740*.-**

PC							
BNi	PN	WT	BK	MBK			
SN	OB	VBB					
PB	BB	PG	BG	SG	PNP	BNP	OX
BOX	WB	BB/OX	PRB/BG	MBK/PB			
RG	BRG	PRB	BRB	GM			
AU	BAU						

1 288,-	1 288,-	1 302,-	1 302,-
1 546,-	1 546,-	1 563,-	1 563,-
1 739,-	1 739,-	1 759,-	1 759,-
1 932,-	1 932,-	1 953,-	1 953,-
2 190,-	2 190,-	2 214,-	2 214,-
2 319,-	2 319,-	2 344,-	2 344,-

RIVA Contemporary 2-Button Split Knob Horizontal / Vertical Trim - Contemporary Mischer mit 2 Knöpfen und 2 Griffen rechts und links - horizontales / vertikales AP-Teil

RIVA Contemporary 3-Button Split Knob Horizontal / Vertical Trim - Contemporary Mischer mit 3 Knöpfen und 2 Griffen rechts und links - horizontales / vertikales AP-Teil

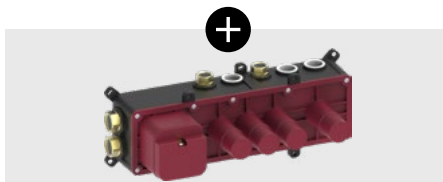
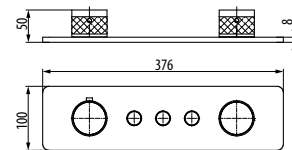
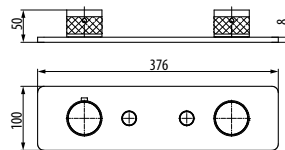

E-18002A

5739010

804,-

RIVA Thermostatic 2-Button Split Knob Rough Valve - Thermostat mit 2 Knöpfen mit distanzierter Steuerung rechts und links - UP-Teil

Details - see page 82 • Details s. Seite 82



E-18003A

5739000

895,-

RIVA Thermostatic 3-Button Split Knob Rough Valve - Thermostat mit 3 Knöpfen mit distanzierter Steuerung rechts und links - UP-Teil

Details - see page 83 • Details s. Seite 83

* D - Diamond knurl - Diamanträndelung / F - Fluted - Rillenrändelung / Q - Oblique knurl - Schrägrändelung / P - Smooth - Ohne Rändelung

** Please specify finish - Bitte die Oberfläche auswählen



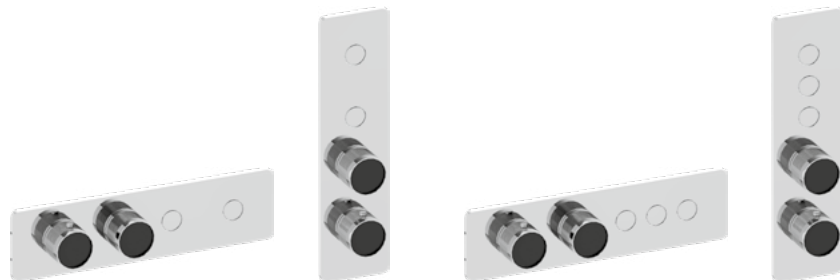
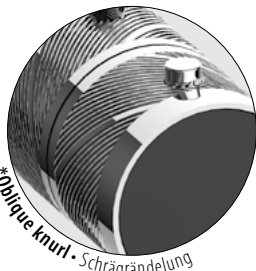
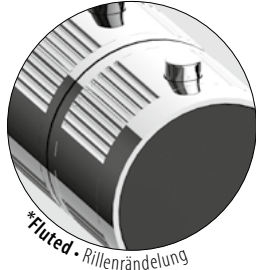

PC							
BNi	PN	WT	BK	MBK			
SN	OB	VBB					
PB	BB	PG	BG	SG	PNP	BNP	OX
BOX	WB	BB/OX	PRB/BG	MBK/PB			
RG	BRG	PRB	BRB	GM			
AU	BAU						

E-18022HB*-**-T	E-18022VB*-**-T	E-18023HB*-**-T	E-18023VB*-**-T
5739570-**-**	5739770-**-**	5739560-**-**	5739760-**-**
1 288,-	1 288,-	1 302,-	1 302,-
1 546,-	1 546,-	1 563,-	1 563,-
1 739,-	1 739,-	1 759,-	1 759,-
1 932,-	1 932,-	1 953,-	1 953,-
2 190,-	2 190,-	2 214,-	2 214,-
2 319,-	2 319,-	2 344,-	2 344,-

RIVA Contemporary 2-Button Paired Knob Horizontal / Vertical Trim - Contemporary Mischer mit 2 Knöpfen und 2 Griffen links - hori-zontales / vertikales AP-Teil

RIVA Contemporary 3-Button Paired Knob Horizontal / Vertical Trim - Contemporary Mischer mit 3 Knöpfen und 2 Griffen links - hori-zontales / vertikales AP-Teil

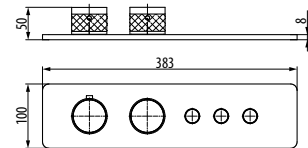
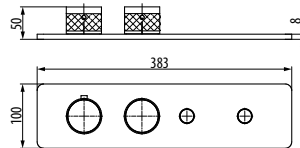

E-18002B
5739030

804,-

RIVA Thermostatic 2-Button Paired Knob Rough Valve - Thermostat mit 2 Knöpfen mit Steuerung links - UP-Teil

Details - see page 82 • Details s. Seite 82

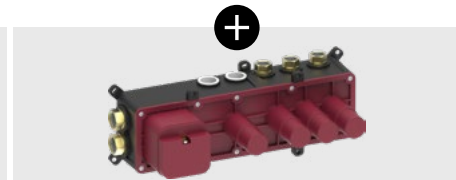

E-18003B
5739020

895,-

RIVA Thermostatic 3-Button Paired Knob Rough Valve - Thermostat mit 3 Knöpfen mit Steuerung links - UP-Teil

Details - see page 83 • Details s. Seite 83

* D - Diamond knurl - Diamanträndelung / F - Fluted - Rillenrändelung / Q - Oblique knurl - Schrägrändelung / P - Smooth - Ohne Rändelung

** Please specify finish - Bitte die Oberfläche auswählen



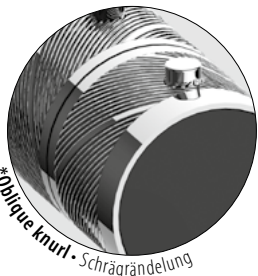
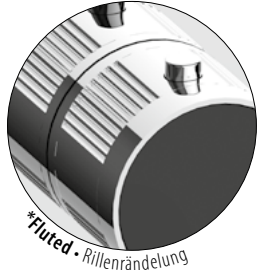

PC							
BNi	PN	WT	BK	MBK			
SN	OB	VBB					
PB	BB	PG	BG	SG	PNP	BNP	OX
BOX	WB	BB/OX	PRB/BG	MBK/PB			
RG	BRG	PRB	BRB	GM			
AU	BAU						

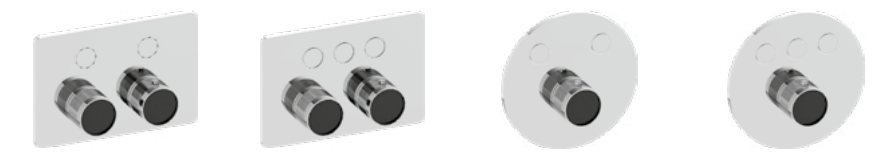

E-18022CC*.-**.-T	E-18023CC*.-**.-T	E-18022RD*.-**.-T	E-18023RD*.-**.-T
5739630-*.**	5739620-*.**	5765990-*.**	5739450-*.**
1 131,-	1 199,-	919,-	1 003,-
1 357,-	1 439,-	1 103,-	1 205,-
1 528,-	1 619,-	1 241,-	1 355,-
1 697,-	1 798,-	1 379,-	1 505,-
1 923,-	2 038,-	1 563,-	1 706,-
2 036,-	2 158,-	1 655,-	1 806,-

RIVA Contemporary 2-Button / 3-Button Compact Trim -
Contemporary Mischer mit 2 Knöpfen / 3 Knöpfen - kompakte Version
- AP-Teil

RIVA Contemporary 2-Button / 3-Button Round Trim -
Contemporary Mischer mit 2 Knöpfen / 3 Knöpfen - rundes AP-Teil

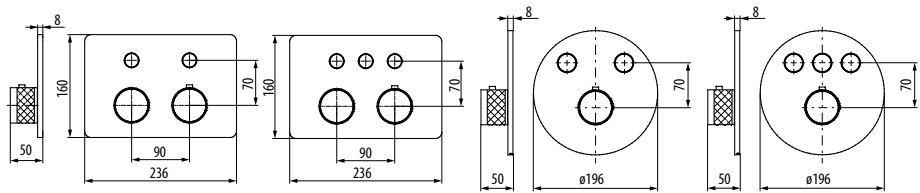

E-18002C	E-18003C	E-18002D	E-18003D
5739050	5739040	5765980	5739440
574,-	574,-	517,-	517,-

RIVA Thermostatic 2-Button Compact Rough Valve - Thermostat mit 2 Knöpfen - kompakte Version - UP-Teil

Details - see page 82
• Details s. Seite 82

RIVA Thermostatic 3-Button Compact Rough Valve - Thermostat mit 3 Knöpfen - kompakte Version - UP-Teil

Details - see page 83
• Details s. Seite 83

RIVA Thermostatic 2-Button Round Rough Valve - Thermostat mit 2 Knöpfen - runde Version - UP-Teil

Details - see page 82
• Details s. Seite 82

RIVA Thermostatic 3-Button Round Rough Valve - Thermostat mit 3 Knöpfen - runde Version - UP-Teil

Details - see page 83
• Details s. Seite 83

* D - Diamond knurl - Diamanträndelung / F - Fluted - Rillenrändelung / Q - Oblique knurl - Schrägrändelung / P - Smooth - Ohne Rändelung

** Please specify finish - Bitte die Oberfläche auswählen

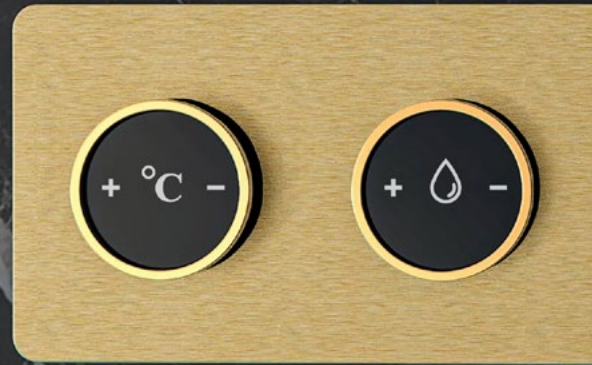
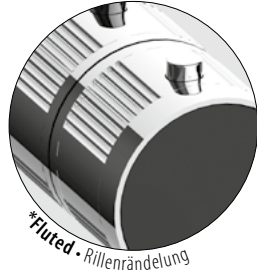

PC							
BNi	PN	WT	BK	MBK			
SN	OB	VBB					
PB	BB	PG	BG	SG	PNP	BNP	OX
BOX	WB	BB/OX	PRB/BG	MBK/PB			
RG	BRG	PRB	BRB	GM			
AU	BAU						

E-18024HA*.-**.-T	!	E-18024VA*.-**.-T	!	E-18025HA*.-**.-T	!	E-18025VA*.-**.-T	!
5739670*.-**		5765950*.-**		5739660*.-**		5765940*.-**	
1 717,-		1 717,-		1 897,-		1 897,-	
2 061,-		2 061,-		2 276,-		2 276,-	
2 319,-		2 319,-		2 562,-		2 562,-	
2 576,-		2 576,-		2 846,-		2 846,-	
2 920,-		2 920,-		3 225,-		3 225,-	
3 092,-		3 092,-		3 415,-		3 415,-	

RIVA Contemporary 4-Button Split Knob Horizontal / Vertical Trim - Contemporary Mischer mit 4 Knöpfen und 2 Griffen rechts und links - horizontales / vertikales AP-Teil

RIVA Contemporary 5-Button Split Knob Horizontal / Vertical Trim - Contemporary Mischer mit 5 Knöpfen und 2 Griffen rechts und links - horizontales / vertikales AP-Teil

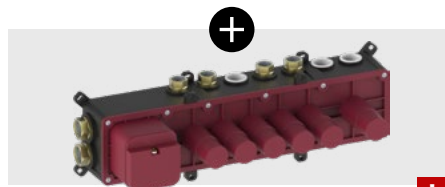
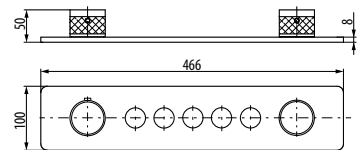
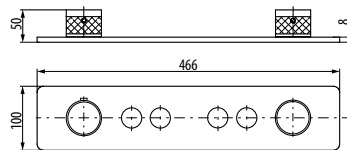

E-18004A

5739410

1 115,-

RIVA Thermostatic 4-Button Split Knob Rough Valve - Thermostat mit 4 Knöpfen mit distanzierter Steuerung rechts und links - UP-Teil

Details - see page 84 • Details s. Seite 84



E-18005A

5739400

1 162,-

RIVA Thermostatic 5-Button Split Knob Rough Valve - Thermostat mit 5 Knöpfen mit distanzierter Steuerung rechts und links - UP-Teil

Details - see page 84 • Details s. Seite 84



E-18024HB*.-** !	E-18024VB*.-** !	E-18025HB*.-** !	E-18025VB*.-** !
5739690.-**	5765970.-**	5739680.-**	5765960.-**
1 717,-	1 717,-	1 897,-	1 897,-
2 061,-	2 061,-	2 276,-	2 276,-
2 319,-	2 319,-	2 562,-	2 562,-
2 576,-	2 576,-	2 846,-	2 846,-
2 920,-	2 920,-	3 225,-	3 225,-
3 092,-	3 092,-	3 415,-	3 415,-

!
Available from the third quarter of 2025
Verfügbar ab dem dritten Quartal 2025

RIVA Contemporary 4-Button Paired Knob Horizontal / Vertical Trim • Contemporary Mischer mit 4 Knöpfen und 2 Griffen links - horizontales / vertikales AP-Teil

RIVA Contemporary 5-Button Paired Knob Horizontal / Vertical Trim • Contemporary Mischer mit 5 Knöpfen und 2 Griffen links - horizontales / vertikales AP-Teil

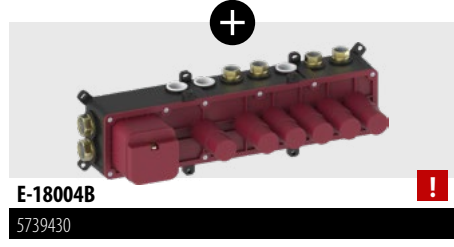
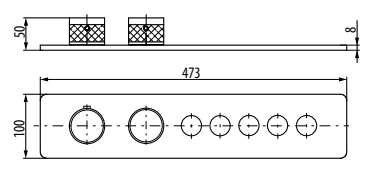
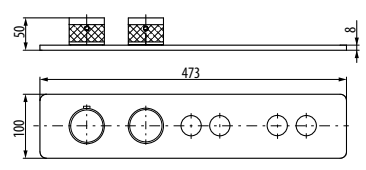

E-18004B !
5739430

1 125,-

RIVA Thermostatic 4-Button Paired Knob Rough Valve • Thermostat mit 4 Knöpfen mit Steuerung links - UP-Teil

Details - see page 84 • Details s. Seite 84

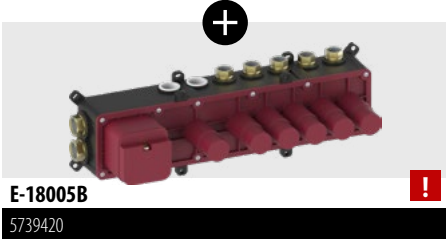

E-18005B !
5739420

1 171,-

RIVA Thermostatic 5-Button Paired Knob Rough Valve • Thermostat mit 5 Knöpfen mit Steuerung links - UP-Teil

Details - see page 84 • Details s. Seite 84

* D - Diamond knurl • Diamanträndelung / F - Fluted • Rillenrändelung / Q - Oblique knurl • Schrägrändelung / P - Smooth • Ohne Rändelung

** Please specify finish • Bitte die Oberfläche auswählen

- PC
- BNi
- PN
- WT
- BK
- MBK
- SN
- OB
- VBB
- PB
- BB
- PG
- BG
- SG
- PNP
- BNP
- OX
- BOX
- WB
- RG
- BRG
- PRB
- BRB
- GM
- AU
- BAU

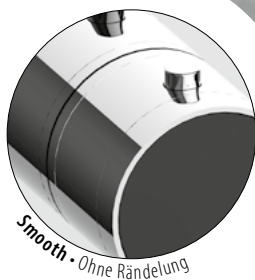

	E-18022HAP-**-T	E-18022VAP-**-T	E-18023HAP-**-T	E-18023VAP-**-T
	5739550-P-**-**	5739750-P-**-**	5739540-P-**-**	5739740-P-**-**
PC	1 288,-	1 288,-	1 302,-	1 302,-
BNi PN WT BK MBK	1 546,-	1 546,-	1 563,-	1 563,-
SN OB VBB	1 739,-	1 739,-	1 759,-	1 759,-
PB BB PG BG SG PNP BNP OX	1 932,-	1 932,-	1 953,-	1 953,-
BOX WB BB/OX PRB/BG MBK/PB	2 190,-	2 190,-	2 214,-	2 214,-
RG BRG PRB BRB GM	2 319,-	2 319,-	2 344,-	2 344,-
AU BAU				

RIVA Contemporary 2-Button Split Knob Horizontal / Vertical Trim - Contemporary Mischer mit 2 Knöpfen und 2 Griffen rechts und links - horizontales / vertikales AP-Teil

RIVA Contemporary 3-Button Split Knob Horizontal / Vertical Trim - Contemporary Mischer mit 3 Knöpfen und 2 Griffen rechts und links - horizontales / vertikales AP-Teil

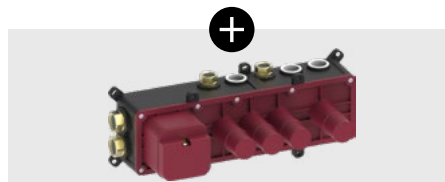
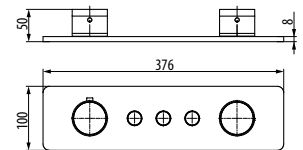
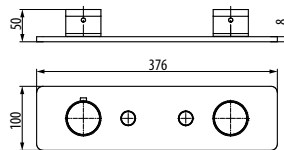

E-18002A	E-18003A
5739010	5739000

804,-

895,-

RIVA Thermostatic 2-Button Split Knob Rough Valve - Thermostat mit 2 Knöpfen mit distanzierter Steuerung rechts und links - UP-Teil

RIVA Thermostatic 3-Button Split Knob Rough Valve - Thermostat mit 3 Knöpfen mit distanzierter Steuerung rechts und links - UP-Teil

Details - see page 82 • Details s. Seite 82

Details - see page 83 • Details s. Seite 83

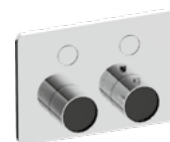

E-18022HBP--T**

E-18022VBP--T**

E-18023HBP--T**

E-18023VBP--T**

E-18022CCP--T**

E-18023CCP--T**

5739570-P-**-

5739770-P-**-

5739560-P-**-

5739760-P-**-

5739630-P-**-

5739620-P-**-

1 288,-

1 288,-

1 302,-

1 302,-

1 131,-

1 199,-

1 546,-

1 546,-

1 563,-

1 563,-

1 357,-

1 439,-

1 739,-

1 739,-

1 759,-

1 759,-

1 528,-

1 619,-

1 932,-

1 932,-

1 953,-

1 953,-

1 697,-

1 798,-

2 190,-

2 190,-

2 214,-

2 214,-

1 923,-

2 038,-

2 319,-

2 319,-

2 344,-

2 344,-

2 036,-

2 158,-

RIVA Contemporary 2-Button Paired Knob Horizontal / Vertical Trim • Contemporary Mischer mit 2 Knöpfen und 2 Griffen links - horizontales / vertikales AP-Teil

RIVA Contemporary 3-Button Paired Knob Horizontal / Vertical Trim • Contemporary Mischer mit 3 Knöpfen und 2 Griffen links - horizontales / vertikales AP-Teil

RIVA Contemporary 2-Button / 3-Button Compact Trim • Contemporary Mischer mit 2 Knöpfen / 3 Knöpfen - kompakte Version - AP-Teil

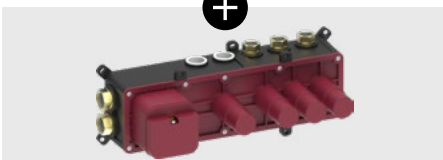
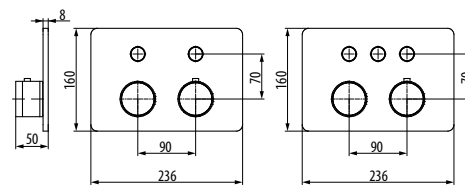
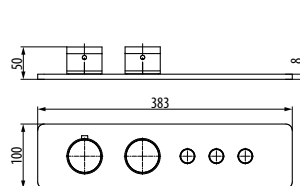
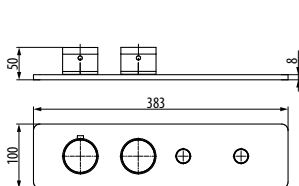

E-18002B

E-18003B

E-18002C

E-18003C

5739030

5739020

5739050

5739040

804,-

895,-

574,-

574,-

RIVA Thermostatic 2-Button Paired Knob Rough Valve • Thermostat mit 2 Knöpfen mit Steuerung links - UP-Teil

RIVA Thermostatic 3-Button Paired Knob Rough Valve • Thermostat mit 3 Knöpfen mit Steuerung links - UP-Teil

RIVA Thermostatic 2-Button Compact Rough Valve • Thermostat mit 2 Knöpfen - kompakte Version - UP-Teil

RIVA Thermostatic 3-Button Compact Rough Valve • Thermostat mit 3 Knöpfen - kompakte Version - UP-Teil

Details - see page 82 • Details s. Seite 82

Details - see page 83 • Details s. Seite 83

Details - see page 82 • Details s. Seite 82

Details - see page 83 • Details s. Seite 83

** Please specify finish • Bitte die Oberfläche auswählen

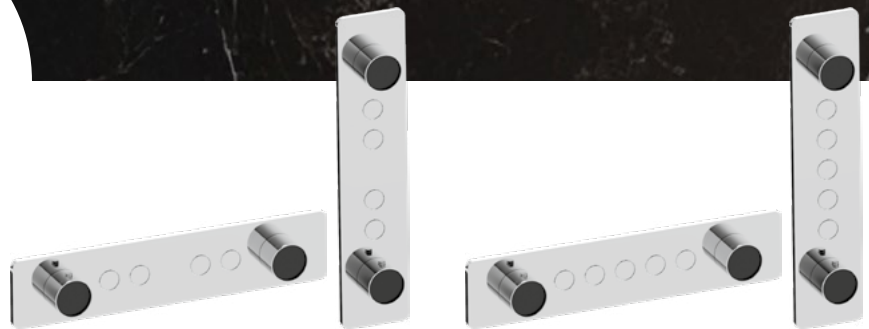
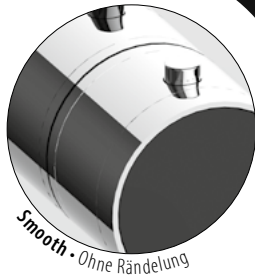

	E-18024HAP-**-T 5739670-P-**-*	E-18024VAP-**-T 5765950-P-**-*	E-18025HAP-**-T 5739660-P-**-*	E-18025VAP-**-T 5765940-P-**-*
PC	1 717,-	1 717,-	1 897,-	1 897,-
BNi PN WT BK MBK	2 061,-	2 061,-	2 276,-	2 276,-
SN OB VBB	2 319,-	2 319,-	2 562,-	2 562,-
PB BB PG BG SG PNP BNP OX	2 576,-	2 576,-	2 846,-	2 846,-
BOX WB BB/OX PRB/BG MBK/PB	2 920,-	2 920,-	3 225,-	3 225,-
RG BRG PRB BRB GM	3 092,-	3 092,-	3 415,-	3 415,-
AU BAU				

RIVA Contemporary 4-Button Split Knob Horizontal / Vertical Trim - Contemporary Mischer mit 4 Knöpfen und 2 Griffen rechts und links - horizontales / vertikales AP-Teil

RIVA Contemporary 5-Button Split Knob Horizontal / Vertical Trim - Contemporary Mischer mit 5 Knöpfen und 2 Griffen rechts und links - horizontales / vertikales AP-Teil

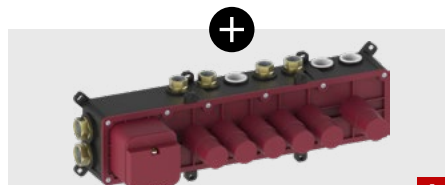
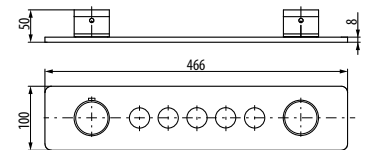
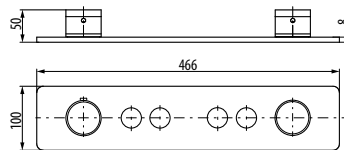

E-18004A
5739410

1 115,-

RIVA Thermostatic 4-Button Split Knob Rough Valve - Thermostat mit 4 Knöpfen mit distanzierter Steuerung rechts und links - UP-Teil

Details - see page 84 • Details s. Seite 84



E-18005A
5739400

1 162,-

RIVA Thermostatic 5-Button Split Knob Rough Valve - Thermostat mit 5 Knöpfen mit distanzierter Steuerung rechts und links - UP-Teil

Details - see page 84 • Details s. Seite 84

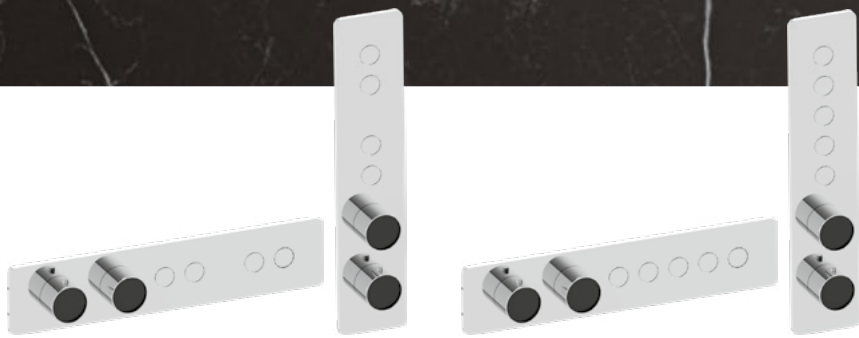

E-18024HBP-**-T !	E-18024VBP-**-T !	E-18025HBP-**-T !	E-18025VBP-**-T !
5739690-P-**-	5765970-P-**-	5739680-P-**-	5765960-P-**-
1 717,-	1 717,-	1 897,-	1 897,-
2 061,-	2 061,-	2 276,-	2 276,-
2 319,-	2 319,-	2 562,-	2 562,-
2 576,-	2 576,-	2 846,-	2 846,-
2 920,-	2 920,-	3 225,-	3 225,-
3 092,-	3 092,-	3 415,-	3 415,-

!
Available from the third quarter of 2025
Verfügbar ab dem dritten Quartal 2025

RIVA Contemporary 4-Button Paired Knob Horizontal / Vertical Trim • Contemporary Mischer mit 4 Knöpfen und 2 Griffen links - horizontales / vertikales AP-Teil

RIVA Contemporary 5-Button Paired Knob Horizontal / Vertical Trim • Contemporary Mischer mit 5 Knöpfen und 2 Griffen links - horizontales / vertikales AP-Teil

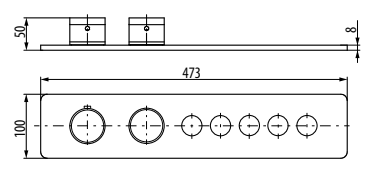
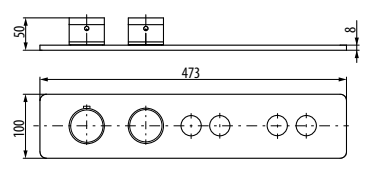

E-18004B !

5739430

1 125,-

E-18005B !

5739420

1 171,-

RIVA Thermostatic 4-Button Paired Knob Rough Valve • Thermostat mit 4 Knöpfen mit Steuerung links - UP-Teil

RIVA Thermostatic 5-Button Paired Knob Rough Valve • Thermostat mit 5 Knöpfen mit Steuerung links - UP-Teil

Details - see page 84 • Details s. Seite 84

Details - see page 84 • Details s. Seite 84

** Please specify finish • Bitte die Oberfläche auswählen

- PC
- BNi
- PN
- WT
- BK
- MBK
- SN
- OB
- VBB
- PB
- BB
- PG
- BG
- SG
- PNP
- BNP
- OX
- BOX
- WB
- RG
- BRG
- PRB
- BRB
- GM
- AU
- BAU





E-18022RDP--T**

E-18023RDP--T**

5765990-P-**-

5739450-P-**-

PC				
BNi	PN	WT	BK	MBK
SN		OB	VBB	
PB	BB	PG	BG	SG
BOX	WB	BB/OX	PRB/BG	MBK/PB
RG	BRG	PRB	BRB	GM
AU		BAU		

919,-

1 003,-

1 103,-

1 205,-

1 241,-

1 355,-

1 379,-

1 505,-

1 563,-

1 706,-

1 655,-

1 806,-

RIVA Contemporary 2-Button / 3-Button Round Trim • Contemporary Mischer mit 2 Knöpfen / 3 Knöpfen - rundes AP-Teil

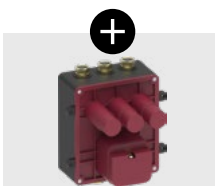
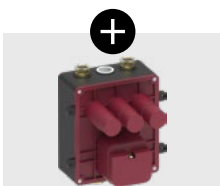
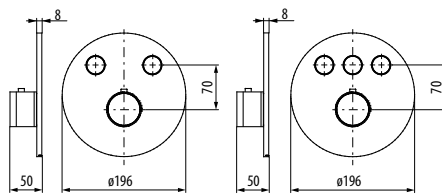

E-18002D

E-18003D

5765980

5739440

517,-

517,-

RIVA Thermostatic 2-Button Round Rough Valve • Thermostat mit 2 Knöpfen - runde Version - UP-Teil

RIVA Thermostatic 3-Button Round Rough Valve • Thermostat mit 3 Knöpfen - runde Version - UP-Teil

Details - see page 82
• Details s. Seite 82

Details - see page 83
• Details s. Seite 83

Refined Aesthetics, Advanced Technology

Beauty and precision define RIVA's design, merging exquisitely refined aesthetics with leading-edge technology.

Forged from materials of the highest caliber, RIVA rises, a new icon of enduring luxury and wellness.

Intricately crafted artisanal details meld aesthetic delight with the physical and emotional pleasures of precision in flow, angle, and temperature.



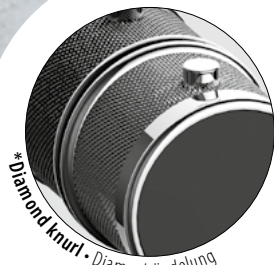

PC							
BNi	PN	WT	BK	MBK			
SN	OB	VBB					
PB	BB	PG	BG	SG	PNP	BNP	OX
BOX	WB	BB/OX	PRB/BG	MBK/PB			
RG	BRG	PRB	BRB	GM	BB/PB/OX		
AU	BAU						

E-18012HA*.-**.-T	E-18012VA*.-**.-T	E-18013HA*.-**.-T	E-18013VA*.-**.-T
5739510-*.-**	5739710-*.-**	5739500-*.-**	5739700-*.-**
1 320,-	1 320,-	1 370,-	1 370,-
1 584,-	1 584,-	1 645,-	1 645,-
1 782,-	1 782,-	1 850,-	1 850,-
1 980,-	1 980,-	2 056,-	2 056,-
2 243,-	2 243,-	2 329,-	2 329,-
2 375,-	2 375,-	2 466,-	2 466,-

RIVA Traditional 2-Button Split Knob Horizontal / Vertical Trim
 • Traditional Mischer mit 2 Knöpfen und 2 Griffen rechts und links - horizontales / vertikales AP-Teil

RIVA Traditional 3-Button Split Knob Horizontal / Vertical Trim
 • Traditional Mischer mit 3 Knöpfen und 2 Griffen rechts und links - horizontales / vertikales AP-Teil

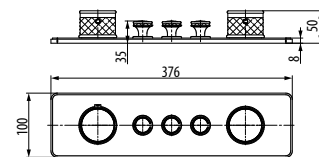
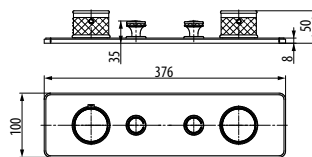

E-18002A
5739010

804,-

RIVA Thermostatic 2-Button Split Knob Rough Valve - Thermostat mit 2 Knöpfen mit distanzierter Steuerung rechts und links - UP-Teil



E-18003A
5739000

895,-

RIVA Thermostatic 3-Button Split Knob Rough Valve - Thermostat mit 3 Knöpfen mit distanzierter Steuerung rechts und links - UP-Teil

Details - see page 82 • Details s. Seite 82

Details - see page 83 • Details s. Seite 83

* D - Diamond knurl • Diamanträndelung / F - Fluted • Rillenrändelung / Q - Oblique knurl • Schrägrändelung / P - Smooth • Ohne Rändelung

** Please specify finish • Bitte die Oberfläche auswählen



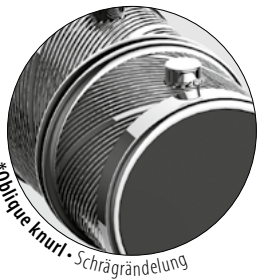
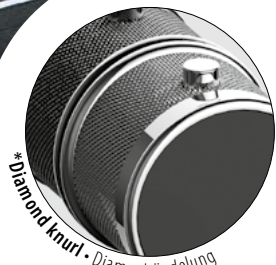

E-18012HB*.--T** **E-18012VB*.-**-T** **E-18013HB*.-**-T** **E-18013VB*.-**-T**

5739530*.-**	5739730*.-**	5739520*.-**	5739720*.-**
1 320,-	1 320,-	1 370,-	1 370,-
1 584,-	1 584,-	1 645,-	1 645,-
1 782,-	1 782,-	1 850,-	1 850,-
1 980,-	1 980,-	2 056,-	2 056,-
2 243,-	2 243,-	2 329,-	2 329,-
2 375,-	2 375,-	2 466,-	2 466,-

PC
BNi PN WT BK MBK
SN OB VBB
PB BB PG BG SG PNP BNP OX
BOX WB BB/OX PRB/BG MBK/PB
RG BRG PRB BRB GM BB/PB/OX
AU BAU

RIVA Traditional 2-Button Paired Knob Horizontal / Vertical Trim • Traditional Mischer mit 2 Knöpfen und 2 Griffen links - horizontales / vertikales AP-Teil

RIVA Traditional 3-Button Paired Knob Horizontal / Vertical Trim • Traditional Mischer mit 3 Knöpfen und 2 Griffen links - horizontales / vertikales AP-Teil

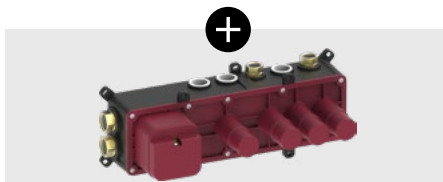
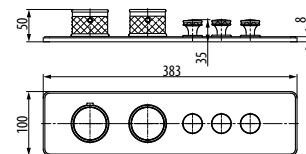
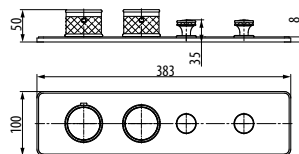

E-18002B

5739030

804,-

RIVA Thermostatic 2-Button Paired Knob Rough Valve • Thermostat mit 2 Knöpfen mit Steuerung links - UP-Teil

Details - see page 82 • Details s. Seite 82

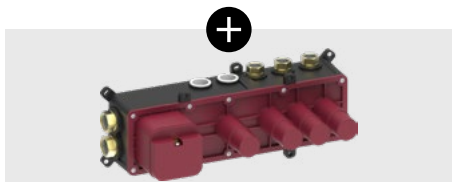

E-18003B

5739020

895,-

RIVA Thermostatic 3-Button Paired Knob Rough Valve • Thermostat mit 3 Knöpfen mit Steuerung links - UP-Teil

Details - see page 83 • Details s. Seite 83

* D - Diamond knurl • Diamanträndelung / F - Fluted • Rillenrändelung / Q - Oblique knurl • Schrägrändelung / P - Smooth • Ohne Rändelung

** Please specify finish • Bitte die Oberfläche auswählen



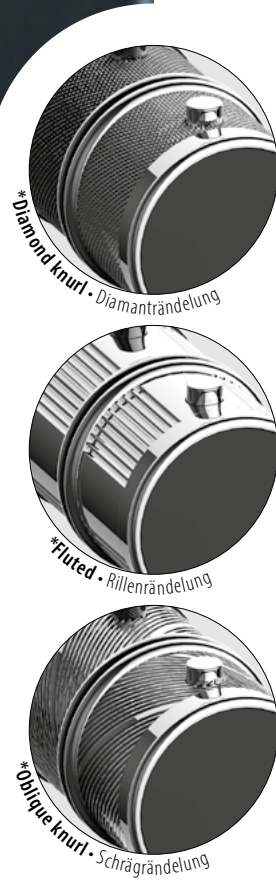

E-18012CC*.-.-T**

E-18013CC*.-.-T**

5739610.-*.-**

5739600.-*.-**

PC					
BNi	PN	WT	BK	MBK	
SN		OB	VBB		
PB	BB	PG	BG	SG	PNP BNP OX
BOX	WB	BB/OX	PRB/BG	MBK/PB	
RG	BRG	PRB	BRB	GM	BB/PB/OX
AU			BAU		

1 149,-

1 193,-

1 379,-

1 432,-

1 552,-

1 610,-

1 724,-

1 790,-

1 954,-

2 028,-

2 069,-

2 148,-

RIVA Traditional 2-Button / 3-Button Compact Trim • Traditional Mischer mit 2 Knöpfen / 3 Knöpfen - kompakte Version - AP-Teil

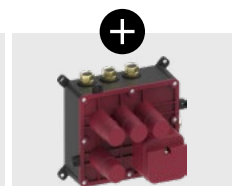
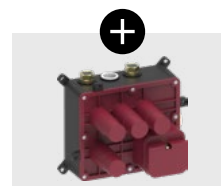
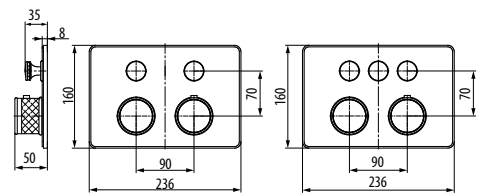

E-18002C

E-18003C

5739050

5739040

574,-

574,-

RIVA Thermostatic 2-Button Compact Rough Valve • Thermostat mit 2 Knöpfen - kompakte Version - UP-Teil

RIVA Thermostatic 3-Button Compact Rough Valve • Thermostat mit 3 Knöpfen - kompakte Version - UP-Teil

Details - see page 82
• Details s. Seite 82

Details - see page 83
• Details s. Seite 83

* D - Diamond knurl • Diamanträndelung / F - Fluted • Rillenrändelung / Q - Oblique knurl • Schrägrändelung / P - Smooth • Ohne Rändelung

** Please specify finish • Bitte die Oberfläche auswählen



*Diamond knurl - Diamanträndelung

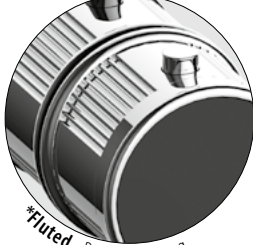

*Fluted - Rillenrändelung

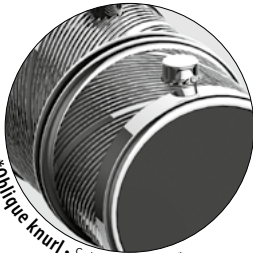

*Oblique knurl - Schrägrändelung



PC				
BNi	PN	WT	BK	MBK
SN		OB	VBB	
PB	BB	PG	BG	SG
PNP	BNP	OX		
BOX	WB	BB/OX	PRB/BG	MBK/PB
RG	BRG	PRB	BRB	GM
BB/PB/OX				
AU		BAU		

E-18014HA*.-**	!	E-18014VA*.-**	!	E-18015HA*.-**	!	E-18015VA*.-**	!
5739590.-**		5765910.-**		5739580.-**		5765900.-**	
1 826,-		1 826,-		2 141,-		2 141,-	
2 191,-		2 191,-		2 570,-		2 570,-	
2 465,-		2 465,-		2 890,-		2 890,-	
2 739,-		2 739,-		3 211,-		3 211,-	
3 103,-		3 103,-		3 639,-		3 639,-	
3 286,-		3 286,-		3 853,-		3 853,-	

RIVA Traditional 4-Button Split Knob Horizontal / Vertical Trim
 • Traditional Mischer mit 4 Knöpfen und 2 Griffen rechts und links - horizontales / vertikales AP-Teil

RIVA Traditional 5-Button Split Knob Horizontal / Vertical Trim
 • Traditional Mischer mit 5 Knöpfen und 2 Griffen rechts und links - horizontales / vertikales AP-Teil

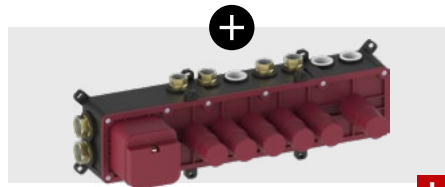
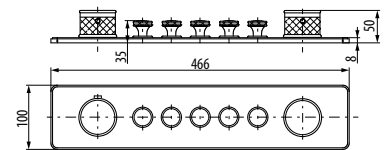
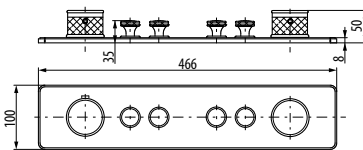

E-18004A
5739410

1 115,-

RIVA Thermostatic 4-Button Split Knob Rough Valve - Thermostat mit 4 Knöpfen mit distanzierter Steuerung rechts und links - UP-Teil

Details - see page 84 • Details s. Seite 84



E-18005A
5739400

1 162,-

RIVA Thermostatic 5-Button Split Knob Rough Valve - Thermostat mit 5 Knöpfen mit distanzierter Steuerung rechts und links - UP-Teil

Details - see page 84 • Details s. Seite 84



E-18014HB*-*-T !	E-18014VB*-*-T !	E-18015HB*-*-T !	E-18015VB*-*-T !
5739650-*-**	5765930-*-**	5739640-*-**	5765920-*-**
1 826,-	1 826,-	2 141,-	2 141,-
2 191,-	2 191,-	2 570,-	2 570,-
2 465,-	2 465,-	2 890,-	2 890,-
2 739,-	2 739,-	3 211,-	3 211,-
3 103,-	3 103,-	3 639,-	3 639,-
3 286,-	3 286,-	3 853,-	3 853,-

RIVA Traditional 4-Button Paired Knob Horizontal / Vertical Trim • Traditional Mischer mit 4 Knöpfen und 2 Griffen links - horizontales / vertikales AP-Teil

RIVA Traditional 5-Button Paired Knob Horizontal / Vertical Trim • Traditional Mischer mit 5 Knöpfen und 2 Griffen links - horizontales / vertikales AP-Teil

!
Available from the third quarter of 2025
Verfügbar ab dem dritten Quartal 2025

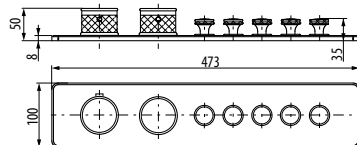
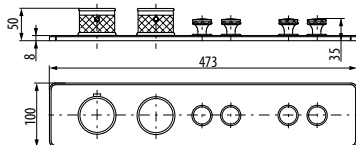

E-18004B !
5739430

1 125,-

RIVA Thermostatic 4-Button Paired Knob Rough Valve • Thermostat mit 4 Knöpfen mit Steuerung links - UP-Teil

Details - see page 84 • Details s. Seite 84



E-18005B !
5739420

1 171,-

RIVA Thermostatic 5-Button Paired Knob Rough Valve • Thermostat mit 5 Knöpfen mit Steuerung links - UP-Teil

Details - see page 84 • Details s. Seite 84

* D - Diamond knurl • Diamanträndelung / F - Fluted • Rillenrändelung / Q - Oblique knurl • Schrägrändelung / P - Smooth • Ohne Rändelung

** Please specify finish • Bitte die Oberfläche auswählen

- PC
- BNi
- PN
- WT
- BK
- MBK
- SN
- OB
- VBB
- PB
- BB
- PG
- BG
- SG
- PNP
- BNP
- OX
- BOX
- WB
- RG
- BRG
- PRB
- BRB
- GM
- AU
- BAU



					E-18012HAP-**-T	E-18012VAP-**-T	E-18013HAP-**-T	E-18013VAP-**-T
					5739510-P-**	5739710-P-**	5739500-P-**	5739700-P-**
PC					1 320,-	1 320,-	1 370,-	1 370,-
BNi	PN	WT	BK	MBK	1 584,-	1 584,-	1 645,-	1 645,-
SN		OB		VBB	1 782,-	1 782,-	1 850,-	1 850,-
PB	BB	PG	BG	SG	PNP	BNP	OX	1 980,-
BOX	WB	BB/OX	PRB/BG	MBK/PB	1 980,-	1 980,-	2 056,-	2 056,-
RG	BRG	PRB	BRB	GM	BB/PB/OX	2 243,-	2 329,-	2 329,-
AU		BAU			2 375,-	2 375,-	2 466,-	2 466,-

RIVA Traditional 2-Button Split Knob Horizontal / Vertical Trim
 • Traditional Mischer mit 2 Knöpfen und 2 Griffen rechts und links - horizontales / vertikales AP-Teil

RIVA Traditional 3-Button Split Knob Horizontal / Vertical Trim
 • Traditional Mischer mit 3 Knöpfen und 2 Griffen rechts und links - horizontales / vertikales AP-Teil

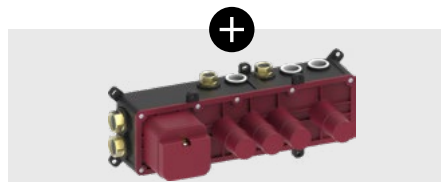
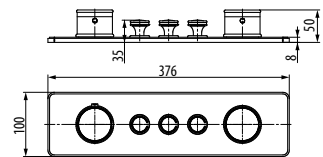
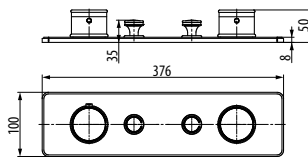

E-18002A

5739010

804,-

RIVA Thermostatic 2-Button Split Knob Rough Valve - Thermostat mit 2 Knöpfen mit distanzierter Steuerung rechts und links - UP-Teil

Details - see page 82 • Details s. Seite 82



E-18003A

5739000

895,-

RIVA Thermostatic 3-Button Split Knob Rough Valve - Thermostat mit 3 Knöpfen mit distanzierter Steuerung rechts und links - UP-Teil

Details - see page 83 • Details s. Seite 83



E-18012HBP--T**

E-18012VBP--T**

E-18013HBP--T**

E-18013VBP--T**

E-18012CCP--T**

E-18013CCP--T**

5739530-P-**-

5739730-P-**-

5739520-P-**-

5739720-P-**-

5739610-P-**-

5739600-P-**-

1 320,-

1 320,-

1 370,-

1 370,-

1 149,-

1 193,-

1 584,-

1 584,-

1 645,-

1 645,-

1 379,-

1 432,-

1 782,-

1 782,-

1 850,-

1 850,-

1 552,-

1 610,-

1 980,-

1 980,-

2 056,-

2 056,-

1 724,-

1 790,-

2 243,-

2 243,-

2 329,-

2 329,-

1 954,-

2 028,-

2 375,-

2 375,-

2 466,-

2 466,-

2 069,-

2 148,-

RIVA Traditional 2-Button Paired Knob Horizontal / Vertical Trim • Traditional Mischer mit 2 Knöpfen und 2 Griffen links - horizontales / vertikales AP-Teil

RIVA Traditional 3-Button Paired Knob Horizontal / Vertical Trim • Traditional Mischer mit 3 Knöpfen und 2 Griffen links - horizontales / vertikales AP-Teil

RIVA Traditional 2-Button / 3-Button Compact Trim • Traditional Mischer mit 2 Knöpfen / 3 Knöpfen - kompakte Version - AP-Teil

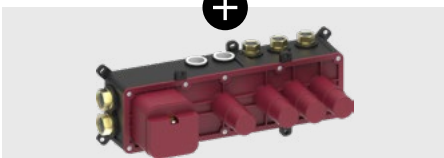
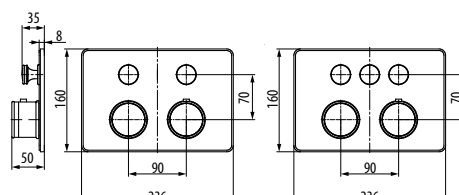
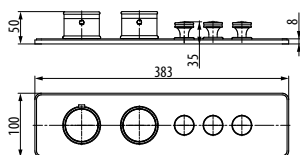
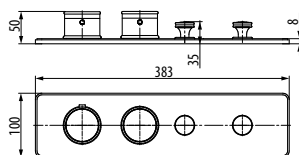

E-18002B

E-18003B

E-18002C

E-18003C

5739030

5739020

5739050

5739040

804,-

895,-

574,-

574,-

RIVA Thermostatic 2-Button Paired Knob Rough Valve • Thermostat mit 2 Knöpfen mit Steuerung links - UP-Teil

RIVA Thermostatic 3-Button Paired Knob Rough Valve • Thermostat mit 3 Knöpfen mit Steuerung links - UP-Teil

RIVA Thermostatic 2-Button Compact Rough Valve • Thermostat mit 2 Knöpfen - kompakte Version - UP-Teil

RIVA Thermostatic 3-Button Compact Rough Valve • Thermostat mit 3 Knöpfen - kompakte Version - UP-Teil

Details - see page 82 • Details s. Seite 82

Details - see page 83 • Details s. Seite 83

Details - see page 82 • Details s. Seite 82

Details - see page 83 • Details s. Seite 83

** Please specify finish • Bitte die Oberfläche auswählen



	E-18014HAP-**-T	E-18014VAP-**-T	E-18015HAP-**-T	E-18015VAP-**-T
	5739590-P-**-	5765910-P-**-	5739580-P-**-	5765900-P-**-
PC	1 826,-	1 826,-	2 141,-	2 141,-
BNi PN WT BK MBK	2 191,-	2 191,-	2 570,-	2 570,-
SN OB VBB	2 465,-	2 465,-	2 890,-	2 890,-
PB BB PG BG SG PNP BNP OX	2 739,-	2 739,-	3 211,-	3 211,-
BOX WB BB/OX PRB/BG MBK/PB				
RG BRG PRB BRB GM BB/PB/OX	3 103,-	3 103,-	3 639,-	3 639,-
AU BAU	3 286,-	3 286,-	3 853,-	3 853,-

RIVA Traditional 4-Button Split Knob Horizontal / Vertical Trim
 • Traditional Mischer mit 4 Knöpfen und 2 Griffen rechts und links - horizontales / vertikales AP-Teil

RIVA Traditional 5-Button Split Knob Horizontal / Vertical Trim
 • Traditional Mischer mit 5 Knöpfen und 2 Griffen rechts und links - horizontales / vertikales AP-Teil

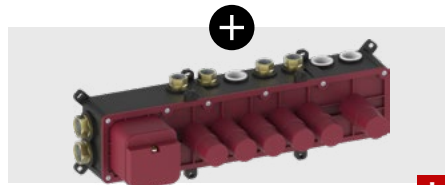
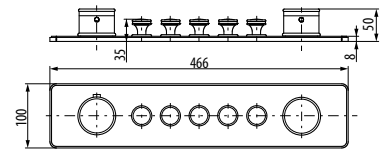
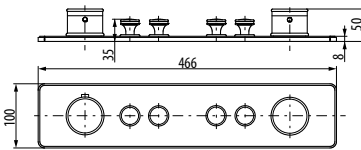

E-18004A
5739410

1 115,-

RIVA Thermostatic 4-Button Split Knob Rough Valve • Thermostat mit 4 Knöpfen mit distanzierter Steuerung rechts und links - UP-Teil

Details - see page 84 • Details s. Seite 84



E-18005A
5739400

1 162,-

RIVA Thermostatic 5-Button Split Knob Rough Valve • Thermostat mit 5 Knöpfen mit distanzierter Steuerung rechts und links - UP-Teil

Details - see page 84 • Details s. Seite 84

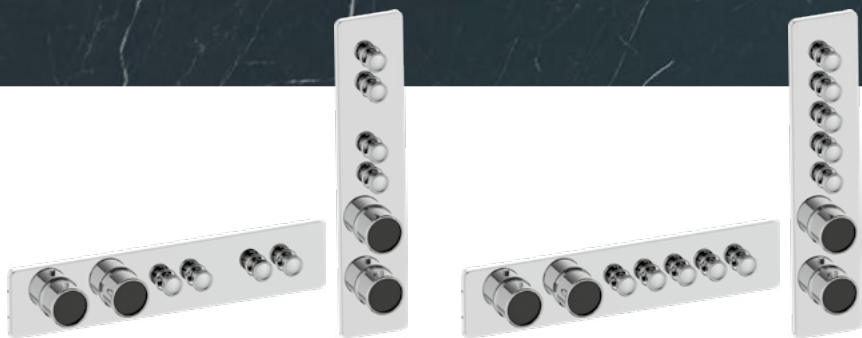

E-18014HBP-**-T !	E-18014VBP-**-T !	E-18015HBP-**-T !	E-18015VBP-**-T !
5739650-P-**-**	5765930-P-**-**	5739640-P-**-**	5765920-P-**-**
1 826,-	1 826,-	2 141,-	2 141,-
2 191,-	2 191,-	2 570,-	2 570,-
2 465,-	2 465,-	2 890,-	2 890,-
2 739,-	2 739,-	3 211,-	3 211,-
3 103,-	3 103,-	3 639,-	3 639,-
3 286,-	3 286,-	3 853,-	3 853,-

!
Available from the third quarter of 2025
Verfügbar ab dem dritten Quartal 2025

RIVA Traditional 4-Button Paired Knob Horizontal / Vertical Trim • Traditional Mischer mit 4 Knöpfen und 2 Griffen links - horizontales / vertikales AP-Teil

RIVA Traditional 5-Button Paired Knob Horizontal / Vertical Trim • Traditional Mischer mit 5 Knöpfen und 2 Griffen links - horizontales / vertikales AP-Teil

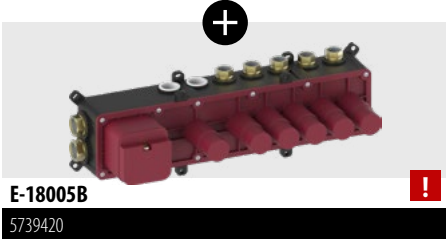
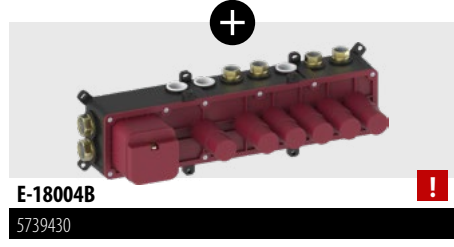
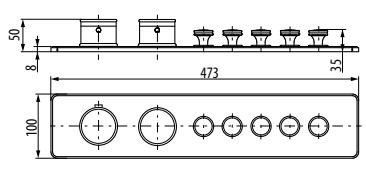
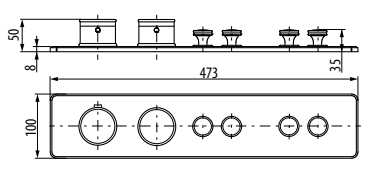

E-18004B !
5739430

E-18005B !
5739420

1 125,-

1 171,-

RIVA Thermostatic 4-Button Paired Knob Rough Valve • Thermostat mit 4 Knöpfen mit Steuerung links - UP-Teil

RIVA Thermostatic 5-Button Paired Knob Rough Valve • Thermostat mit 5 Knöpfen mit Steuerung links - UP-Teil

Details - see page 84 • Details s. Seite 84

Details - see page 84 • Details s. Seite 84

** Please specify finish • Bitte die Oberfläche auswählen

- PC
- BNi
- PN
- WT
- BK
- MBK
- SN
- OB
- VBB
- PB
- BB
- PG
- BG
- SG
- PNP
- BNP
- OX
- BOX
- WB
- RG
- BRG
- PRB
- BRB
- GM
- AU
- BAU

Thermostatic Rough Valves



E-18002A

5739010

804,-

RIVA Thermostatic 2-Button Split Knob Rough Valve • Thermostat mit 2 Knöpfen mit distanzierter Steuerung rechts und links - UP-Teil



E-18002B

5739030

804,-

RIVA Thermostatic 2-Button Paired Knob Rough Valve • Thermostat mit 2 Knöpfen mit Steuerung links - UP-Teil



E-18002C

5739050

574,-

RIVA Thermostatic 2-Button Compact Rough Valve • Thermostat mit 2 Knöpfen - kompakte Version - UP-Teil



E-18002D

5765980

517,-

RIVA Thermostatic 2-Button Round Rough Valve • Thermostat mit 2 Knöpfen - runde Version - UP-Teil

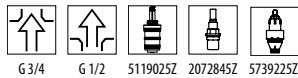

G3/4 G1/2 5119025Z 2072845Z 5739225Z

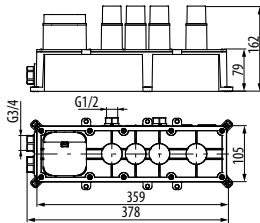

G3/4 G1/2 5119025Z 2072845Z 5739225Z

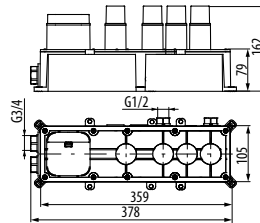

G3/4 G1/2 5119025Z 2072845Z 5739225Z

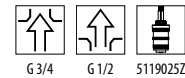
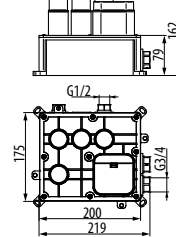

G3/4 G1/2 5119025Z

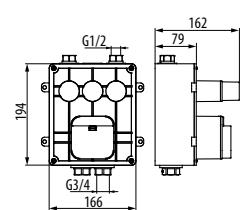

5788510

5788510

172,-

Extension for E-18002A, E-18002B, E-18002C +25mm • Verlängerung für E-18002A, E-18002B, E-18002C +25mm

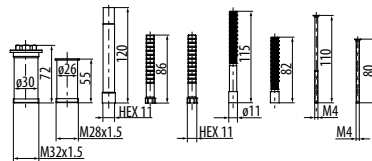

5788530

5788530

132,-

Extension for E-18002D +25mm • Verlängerung für E-18002D +25mm

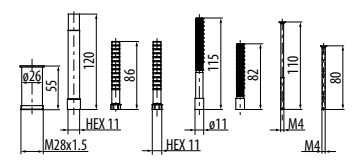

5788610

5788610

222,-

Extension for E-18002A, E-18002B, E-18002C +50mm • Verlängerung für E-18002A, E-18002B, E-18002C +50mm

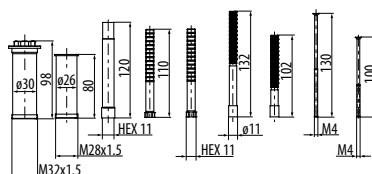

5788630

5788630

178,-

Extension for E-18002D +25mm • Verlängerung für E-18002D +25mm

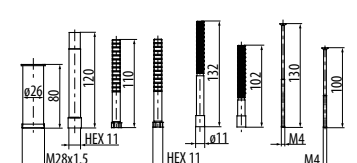



E-18003A

5739000

895,-

RIVA Thermostatic 3-Button Split Knob Rough Valve - Thermostat mit 3 Knöpfen mit distanzierter Steuerung rechts und links - UP-Teil



E-18003B

5739020

895,-

RIVA Thermostatic 3-Button Paired Knob Rough Valve - Thermostat mit 3 Knöpfen mit Steuerung links - UP-Teil



E-18003C

5739040

574,-

RIVA Thermostatic 3-Button Compact Rough Valve - Thermostat mit 3 Knöpfen - kompakte Version - UP-Teil



E-18003D

5739440

517,-

RIVA Thermostatic 3-Button Round Rough Valve - Thermostat mit 3 Knöpfen - runde Version - UP-Teil



G 3/4 G 1/2 5119025Z 2072845Z 5739225Z



G 3/4 G 1/2 5119025Z 2072845Z 5739225Z



G 3/4 G 1/2 5119025Z 2072845Z 5739225Z

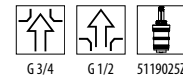

G 3/4 G 1/2 5119025Z

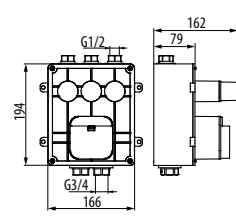
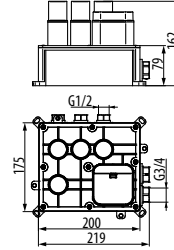
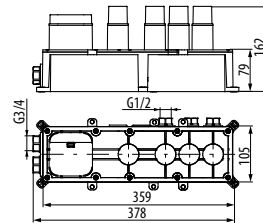
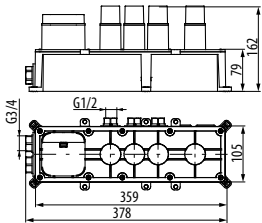

5788500

5788500

188,-

Extension for E-18003A, E-18003B, E-18003C +25mm - Verlängerung für E-18003A, E-18003B, E-18003C +25mm



5788520

5788520

148,-

Extension for E-18003D +25mm - Verlängerung für E-18003D +25mm

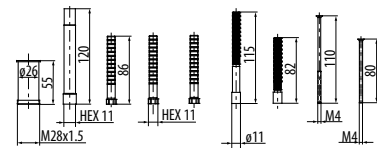
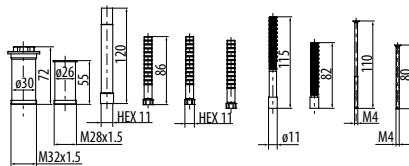

5788600

5788600

240,-

Extension for E-18003A, E-18003B, E-18003C +50mm - Verlängerung für E-18003A, E-18003B, E-18003C +50mm

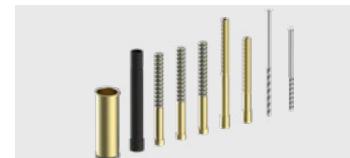

5788620

5788620

195,-

Extension for E-18003D +50mm - Verlängerung für E-18003D +50mm

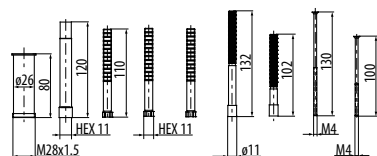
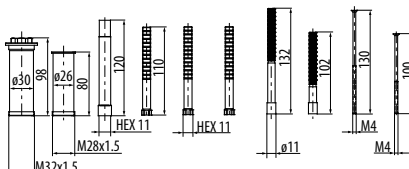



E-18004A

5739410

1115,-

RIVA Thermostatic 4-Button Split Knob Rough Valve • Thermostat mit 4 Knöpfen mit distanzierter Steuerung rechts und links - UP-Teil



E-18004B

5739430

1125,-

RIVA Thermostatic 4-Button Paired Knob Rough Valve • Thermostat mit 4 Knöpfen mit Steuerung links - UP-Teil



E-18005A

5739400

1162,-

RIVA Thermostatic 5-Button Split Knob Rough Valve • Thermostat mit 5 Knöpfen mit distanzierter Steuerung rechts und links - UP-Teil



E-18005B

5739420

1171,-

RIVA Thermostatic 5-Button Paired Knob Rough Valve • Thermostat mit 5 Knöpfen mit Steuerung links - UP-Teil



G 3/4 G 1/2 5119025Z 2072845Z 5739225Z

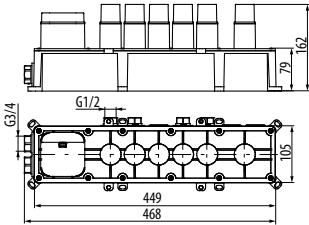

G 3/4 G 1/2 5119025Z 2072845Z 5739225Z

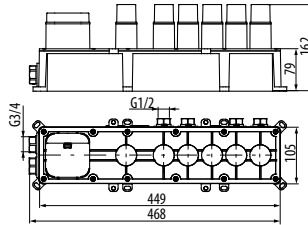

G 3/4 G 1/2 5119025Z 2072845Z 5739225Z

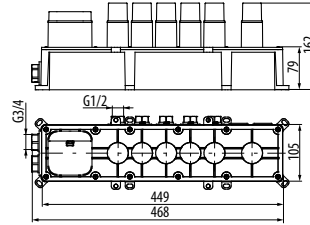

G 3/4 G 1/2 5119025Z 2072845Z 5739225Z

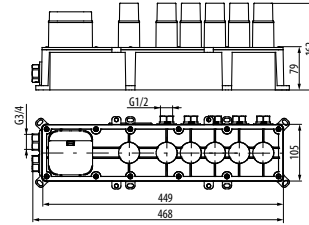

5788540

5788540

204,-

Extension for E-18004A, E-18004B +25mm • Verlängerung für E-18004A, E-18004B +25mm

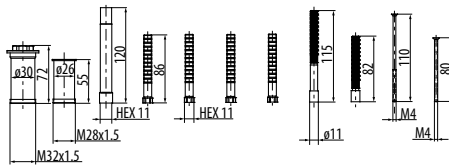

5788550

5788550

220,-

Extension for E-18005A, E-18005B +25mm • Verlängerung für E-18005A, E-18005B +25mm

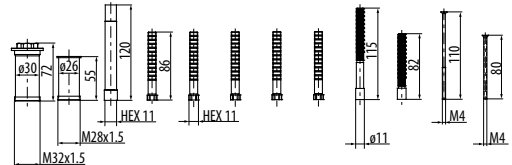

5788640

5788640

257,-

Extension for E-18004A, E-18004B +50mm • Verlängerung für E-18004A, E-18004B +50mm

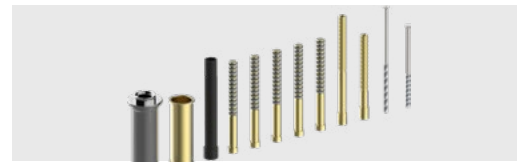
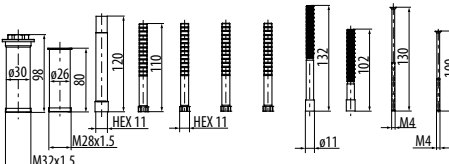

5788650

5788650

275,-

Extension for E-18005A, E-18005B +50mm • Verlängerung für E-18005A, E-18005B +50mm

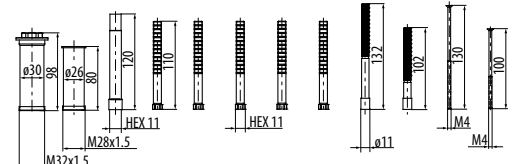



Available from the third quarter of 2025
Verfügbar ab dem dritten Quartal 2025



Inlet
Eingang



Outlet
Ausgang



Thermostatic head
Thermostatkopf



Ceramic head
Keramikscheibenkartusche



Valve FSG D8
FSG-Ventil D8

Rough Valve Flow Rates (l/min) • Durchflussmenge der Ventile (l/min)						
CODE	OUTPUT • AUSGABE	PRESSURE • DRUCK				
		1 bar	2 bar	3 bar	4 bar	5 bar
E-18002A	●	14	21	26	29	33
	●●●	13	19	24	28	31
	● & ●●●	17	24	30	35	40
E-18002B	●	15	21	26	30	33
	●●●	13	19	24	27	31
	● & ●●●	17	25	31	36	40
E-18002C	●	15	22	26	30	33
	●●●	14	21	25	29	32
	● & ●●●	18	26	32	37	41
E-18002D	●	15	22	26	30	34
	●●●	15	21	26	30	34
	● & ●●●	20	30	36	42	48
E-18003A	●	15	21	26	30	33
	●●	14	21	25	28	32
	●●●	14	19	24	28	31
	● & ●●	17	25	31	36	39
	● & ●● & ●●●	17	25	32	37	41
E-18003B	●	15	21	26	30	34
	●●	14	20	25	28	31
	●●●	13	19	23	27	30
	● & ●●	17	25	32	36	41
	● & ●● & ●●●	18	26	33	38	43
E-18003C	●	15	21	26	29	33
	●●	14	20	25	28	32
	●●●	14	20	25	28	32
	● & ●●	17	25	32	37	41
	● & ●● & ●●●	18	27	33	38	43
E-18003D	●	15	22	26	30	34
	●●	16	23	28	32	36
	●●●	15	21	26	30	34
	● & ●●	20	29	35	41	46
	● & ●● & ●●●	21	30	37	43	49
E-18004A	●	15	21	26	29	32
	●●	15	21	25	29	32
	●●●●	15	21	25	29	32
	●●●●●	14	20	24	28	31
	● & ●●	16	24	30	35	40
	● & ●● & ●●●●	17	25	31	36	40
	● & ●● & ●●● & ●●●●●	17	25	31	36	40
E-18004B	●	15	21	26	30	33
	●●	15	22	27	30	33
	●●●●	15	21	26	30	33
	●●●●●	15	21	26	30	33
	● & ●●	18	26	31	36	41
	● & ●● & ●●●●	18	26	33	38	43
	● & ●● & ●●● & ●●●●●	18	27	33	38	43
E-18005A	●	15	21	26	29	32
	●●	15	21	25	29	32
	●●●	15	21	25	29	32
	●●●●	15	21	25	29	32
	●●●●●	14	20	24	28	31
	● & ●●	16	24	30	35	40
	● & ●● & ●●●●	17	25	31	36	40
	● & ●● & ●●● & ●●●●●	17	25	31	36	40
	● & ●● & ●●● & ●●●●● & ●●●●●	17	25	31	36	41
E-18005B	●	15	21	26	30	33
	●●	15	22	27	30	33
	●●●	15	21	26	30	34
	●●●●	15	21	26	30	33
	●●●●●	15	21	26	30	33
	● & ●●	18	26	31	36	41
	● & ●● & ●●●●	18	26	32	38	42
	● & ●● & ●●● & ●●●●●	18	27	33	38	43
		● & ●● & ●●● & ●●●●● & ●●●●●	18	26	33	38

Accessories



E-8706C*..**

5775020-*.**

E-8751C*..**

5775120-*.**

E-8697C*..**

5775060-*.**

E-8804C*..**

5775160-*.**

PC				
BNi	PN	WT	BK	MBK
SN		OB		VBB
PB	BB	PG	BG	SG
PNP	BNP	OX		
BOX	WB	BB/OX	PRB/BG	MBK/PB
RG	BRG	PRB	BRB	GM
AU		BAU		

1 299,-
1 559,-
1 754,-
1 949,-
2 208,-
2 338,-

657,-
789,-
887,-
986,-
1 117,-
1 183,-

674,-
810,-
911,-
1 011,-
1 147,-
1 214,-

398,-
479,-
539,-
597,-
678,-
717,-

RIVA Contemporary Handshower with Slide Bar Set • Contemporary Duschgarnitur mit Gleitstange

RIVA Contemporary Slide Bar • Contemporary Gleitstange

RIVA Contemporary Handshower with Wall Bracket and Integrated Wall Supply Elbow • Contemporary Schlauchbrausegarnitur für Wandmontage

RIVA Contemporary Handshower • Contemporary Handbrause

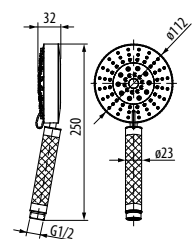
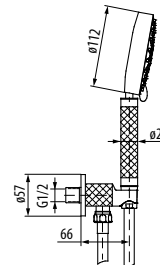
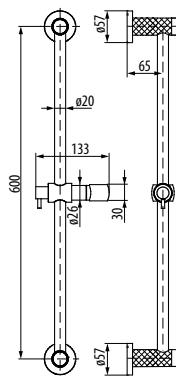
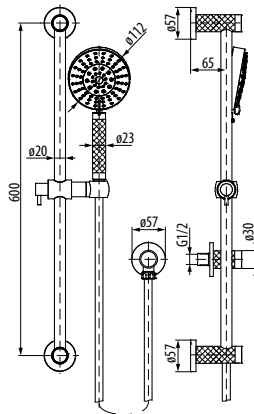

E-8605..**

5338000-**.**

PC				
BNi	PN	WT	BK	MBK
SN		OB		VBB
PB	BB	PG	BG	SG
PNP	BNP	OX	BOX	WB
RG	BRG	PRB	BRB	GM
AU		BAU		

78,-
94,-
105,-
117,-
132,-
140,-

Shower hose • Brauseschlauch



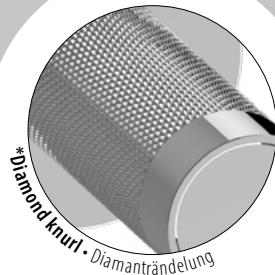

*Diamond knurl - Diamanträndelung

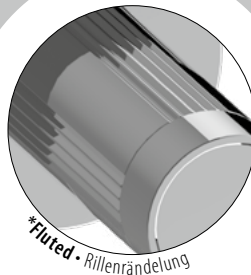

*Fluted - Rillenrändelung

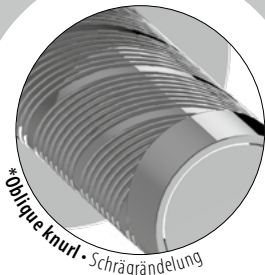

*Oblique knurl - Schrägrändelung

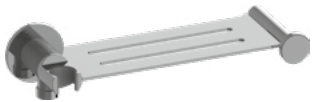

E-19401C*..**

5775310-*.**

503,-

604,-

679,-

755,-

855,-

906,-



E-8752*..**

5795240-*.**

266,-

320,-

359,-

400,-

452,-

479,-



E-8618C*..**

5775240-*.**

197,-

237,-

266,-

296,-

335,-

355,-



E-8713C*..**

5775200-*.**

165,-

198,-

224,-

248,-

281,-

297,-



E-19404C*..**

5775330-*.**

99,-

120,-

135,-

149,-

170,-

179,-

RIVA Contemporary integrated wall supply elbow, Bracket, Shelf and Hook - Contemporary Seifenablage mit integriertem Brausehalter für Handbrause, Wasseranschluss und Haken

RIVA Contemporary Wall bracket for hand shower - Contemporary Brausehalter für Handbrause

RIVA Contemporary Wall Bracket and Integrated Wall Supply Elbow - Contemporary Brausehalter für Handbrause mit integriertem Wasseranschluss

RIVA Contemporary Wall Supply Elbow - Contemporary Wasseranschluss

RIVA Contemporary Towel hook - Contemporary Kleiderhaken

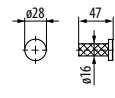
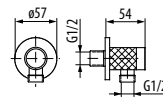
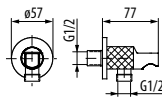
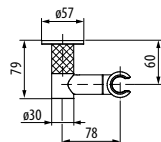
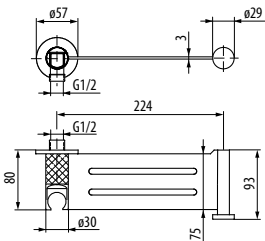

E-19407C*..**

5775370-*.**

401,-

481,-

541,-

601,-

681,-

722,-

E-19408C*..**

5775090-*.**

427,-

513,-

577,-

641,-

726,-

769,-

E-19409C*..**

5775910-*.**

442,-

531,-

597,-

663,-

751,-

796,-

PC							
BNi	PN	WT	BK	MBK			
SN	OB	VBB					
PB	BB	PG	BG	SG	PNP	BNP	OX
BOX	WB	BB/OX	PRB/BG	MBK/PB			
RG	BRG	PRB	BRB	GM			
AU	BAU						

RIVA Contemporary 47,3 cm Towel Bar - Contemporary Handtuchhalter 47,3 cm

RIVA Contemporary 61,4 cm Towel Bar - Contemporary Handtuchhalter 61,4 cm

RIVA Contemporary 77,6 cm Towel Bar - Contemporary Handtuchhalter 77,6 cm

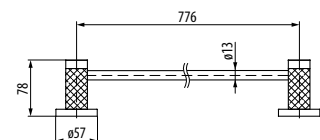
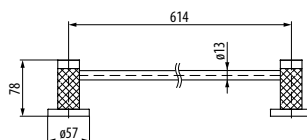
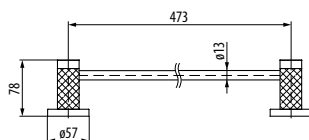

* D - Diamond knurl - Diamanträndelung / F - Fluted - Rillenrändelung / Q - Oblique knurl - Schrägrändelung / P - Smooth - Ohne Rändelung

** Please specify finish - Bitte die Oberfläche auswählen

Accessories



E-8706CP-**

5775020-P-**

1 247,-

E-8751CP-**

5775120-P-**

643,-

E-8697CP-**

5775060-P-**

632,-

E-8804-**

5554450-**

358,-

PC				
BNi	PN	WT	BK	MBK
SN		OB		VBB
PB	BB	PG	BG	SG
PNP	BNP	OX		
BOX	WB	BB/OX	PRB/BG	MBK/PB
RG	BRG	PRB	BRB	GM
AU		BAU		

1 497,-
1 684,-
1 870,-
2 120,-
2 245,-

772,-
869,-
965,-
1 094,-
1 159,-

758,-
854,-
948,-
1 075,-
1 138,-

431,-
483,-
538,-
609,-
644,-

RIVA Contemporary Handshower with Slide Bar Set - Contemporary Duschgarnitur mit Gleitstange

RIVA Contemporary Slide Bar - Contemporary Gleitstange

RIVA Contemporary Handshower with Wall Bracket and Integrated Wall Supply Elbow - Contemporary Schlauchbrausegarnitur für Wandmontage

RIVA Contemporary Handshower - Contemporary Handbrause

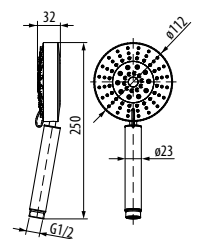
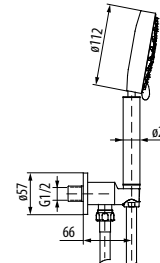
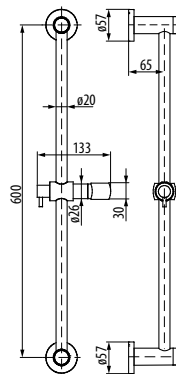
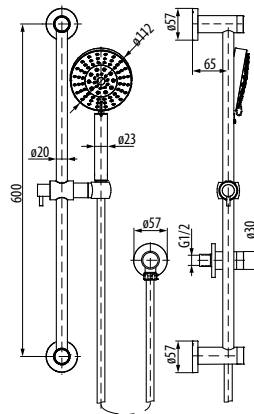

E-8605-**

5338000-**

PC				
BNi	PN	WT	BK	MBK
SN		OB		VBB
PB	BB	PG	BG	SG
PNP	BNP	OX	BOX	WB
RG	BRG	PRB	BRB	GM
AU		BAU		

78,-
94,-
105,-
117,-
132,-
140,-

Shower hose - Brauseschlauch



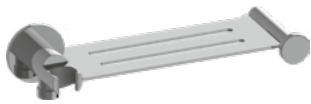
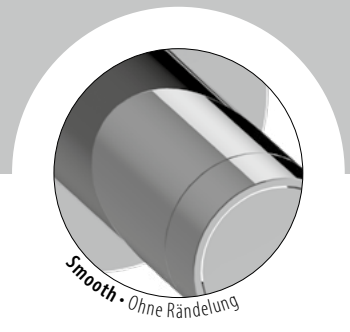

E-19401CP-**

5775310-P-**

460,-
552,-
621,-
690,-
782,-
828,-



E-8752P-**

5795240-P-**

263,-
316,-
355,-
394,-
447,-
473,-



E-8618CP-**

5775240-P-**

184,-
221,-
249,-
276,-
313,-
332,-



E-8713CP-**

5775200-P-**

157,-
189,-
212,-
235,-
267,-
282,-



E-19404CP-**

5775330-P-**

88,-
106,-
119,-
132,-
150,-
158,-

RIVA Contemporary integrated wall supply elbow, Bracket, Shelf and Hook - Contemporary Seifenablage mit integriertem Brausehalter für Handbrause, Wasseranschluss und Haken

RIVA Contemporary Wall bracket for hand shower - Contemporary Brausehalter für Handbrause

RIVA Contemporary Wall Bracket and Integrated Wall Supply Elbow - Contemporary Brausehalter für Handbrause mit integriertem Wasseranschluss

RIVA Contemporary Wall Supply Elbow - Contemporary Wasseranschluss

RIVA Contemporary Towel hook - Contemporary Kleiderhaken

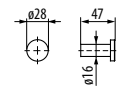
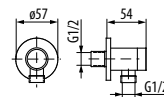
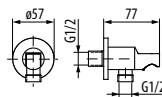
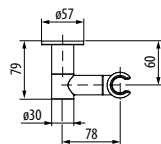
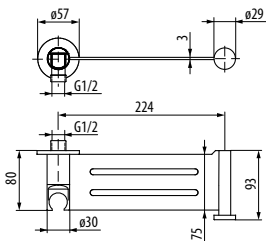

E-19407CP-**

5775370-P-**

382,-
459,-
517,-
573,-
650,-
688,-

E-19408CP-**

5775090-P-**

408,-
489,-
550,-
611,-
693,-
734,-

E-19409CP-**

5775910-P-**

421,-
506,-
570,-
632,-
717,-
758,-

PC							
BNi	PN	WT	BK	MBK			
SN	OB	VBB					
PB	BB	PG	BG	SG	PNP	BNP	OX
BOX	WB	BB/OX	PRB/BG	MBK/PB			
RG	BRG	PRB	BRB	GM			
AU	BAU						

RIVA Contemporary 47,3 cm Towel Bar - Contemporary Handtuchhalter 47,3 cm

RIVA Contemporary 61,4 cm Towel Bar - Contemporary Handtuchhalter 61,4 cm

RIVA Contemporary 77,6 cm Towel Bar - Contemporary Handtuchhalter 77,6 cm

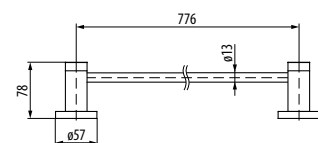
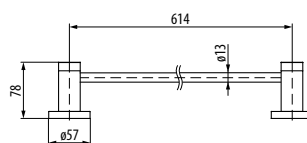
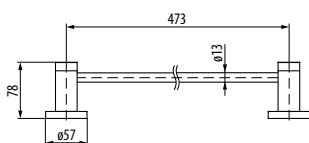

** Please specify finish - Bitte die Oberfläche auswählen

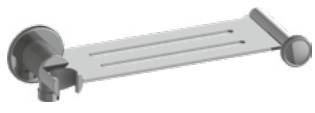
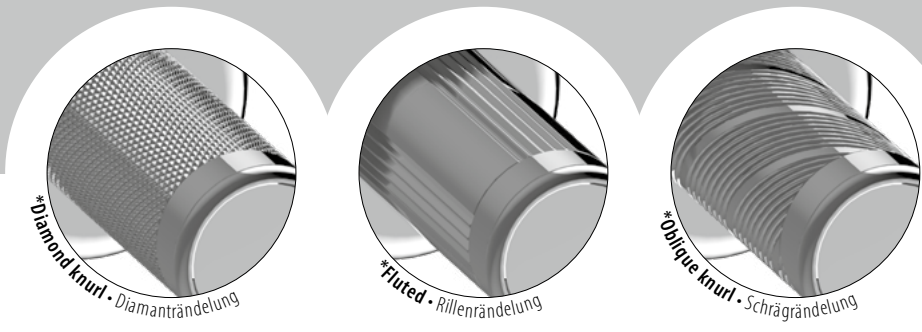

E-19401T*..**
5775300-*..**
538,-
646,-
726,-
807,-
914,-
968,-



E-8762*..**
5795250-*..**
282,-
339,-
381,-
424,-
480,-
508,-



E-8618T*..**
5775220-*..**
210,-
252,-
283,-
314,-
357,-
378,-



E-8713T*..**
5775180-*..**
182,-
219,-
247,-
273,-
310,-
328,-



E-19404T*..**
5775320-*..**
110,-
132,-
149,-
165,-
187,-
197,-

RIVA Traditional integrated wall supply elbow, Bracket, Shelf and Hook • Traditional Seifenablage mit integriertem Brausehalter für Handbrause, Wasseranschluss und Haken

RIVA Traditional Wall bracket for hand shower • Traditional Brausehalter für Handbrause

RIVA Traditional Wall Bracket and Integrated Wall Supply Elbow • Traditional Brausehalter für Handbrause mit integriertem Wasseranschluss

RIVA Traditional Wall Supply Elbow • Traditional Wasseranschluss

RIVA Traditional Towel hook • Traditional Kleiderhaken

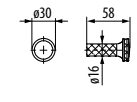
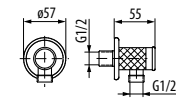
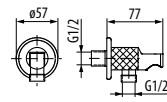
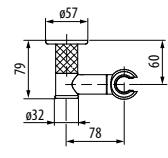
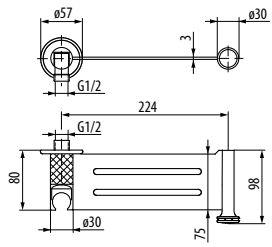

E-19407T*..**
5775360-*..**
441,-
529,-
596,-
662,-
750,-
794,-

E-19408T*..**
5775080-*..**
471,-
565,-
636,-
707,-
801,-
848,-

E-19409T*..**
5775900-*..**
486,-
584,-
656,-
728,-
826,-
874,-

PC
BNi PN WT BK MBK
SN OB VBB
PB BB PG BG SG PNP BNP OX
BOX WB BB/OX PRB/BG MBK/PB
RG BRG PRB BRB GM
AU BAU

RIVA Traditional 47,3 cm Towel Bar • Traditional Handtuchhalter 47,3 cm

RIVA Traditional 61,4 cm Towel Bar • Traditional Handtuchhalter 61,4 cm

RIVA Traditional 77,6 cm Towel Bar • Traditional Handtuchhalter 77,6 cm

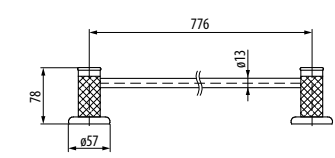
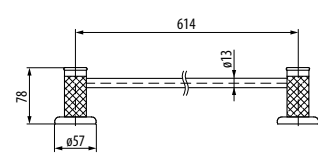
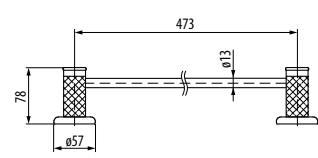

* D - Diamond knurl • Diamanträndelung / F - Fluted • Rillenrändelung / Q - Oblique knurl • Schrägrändelung / P - Smooth • Ohne Rändelung

** Please specify finish • Bitte die Oberfläche auswählen

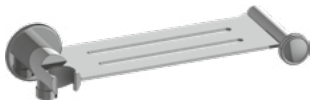
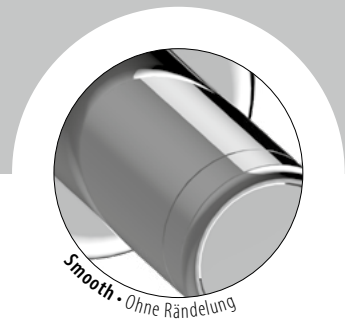

E-19401TP.**

5775300-P.**

494,-

593,-

667,-

741,-

840,-

889,-



E-8762P.**

5795250-P.**

276,-

332,-

373,-

414,-

470,-

497,-



E-8618TP.**

5775220-P.**

196,-

235,-

265,-

294,-

333,-

352,-



E-8713TP.**

5775180-P.**

173,-

207,-

234,-

259,-

294,-

311,-



E-19404TP.**

5775320-P.**

97,-

117,-

132,-

145,-

165,-

175,-

RIVA Traditional integrated wall supply elbow, Bracket, Shelf and Hook • Traditional Seifenablage mit integriertem Brausehalter für Handbrause, Wasseranschluss und Haken

RIVA Traditional Wall bracket for hand shower • Traditional Brausehalter für Handbrause

RIVA Traditional Wall Bracket and Integrated Wall Supply Elbow • Traditional Brausehalter für Handbrause mit integriertem Wasseranschluss

RIVA Traditional Wall Supply Elbow • Traditional Wasseranschluss

RIVA Traditional Towel hook • Traditional Kleiderhaken

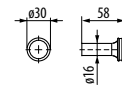
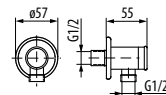
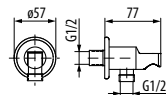
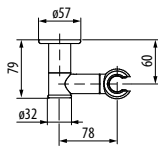
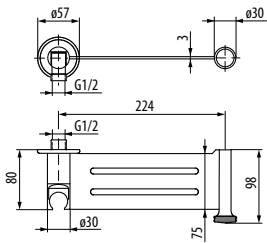

E-19407TP.**

5775360-P.**

420,-

504,-

567,-

631,-

715,-

756,-

E-19408TP.**

5775080-P.**

448,-

538,-

605,-

672,-

762,-

807,-

E-19409TP.**

5775900-P.**

463,-

556,-

625,-

694,-

787,-

833,-

PC							
BNi	PN	WT	BK	MBK			
SN	OB	VBB					
PB	BB	PG	BG	SG	PNP	BNP	OX
BOX	WB	BB/OX	PRB/BG	MBK/PB			
RG	BRG	PRB	BRB	GM			
AU	BAU						

RIVA Traditional 47,3 cm Towel Bar • Traditional Handtuchhalter 47,3 cm

RIVA Traditional 61,4 cm Towel Bar • Traditional Handtuchhalter 61,4 cm

RIVA Traditional 77,6 cm Towel Bar • Traditional Handtuchhalter 77,6 cm

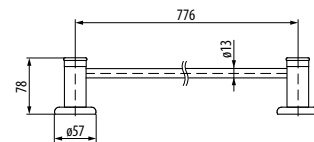
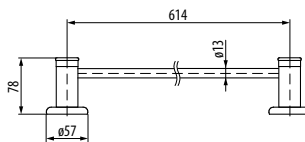
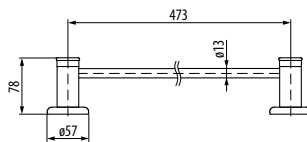

** Please specify finish • Bitte die Oberfläche auswählen





Spare Parts



5119025Z
5119025Z

181,90

Thermostatic head • Keramische Kartusche



2072845Z
2072845Z

59,80

Ceramic head 3/4" • Keramik-scheibenkartusche 3/4"



5739225Z
5739225Z

40,50

Valve FSG D8 • FSG-Ventil D8



5777755Z
5777755Z

11,30

Waterfall Nozzle • Wasserfall-düse



5783115Z
5783115Z

19,-

Waterfall Nozzle • Wasserfalldüse

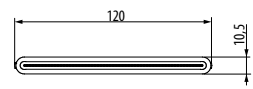
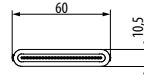
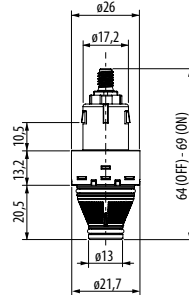
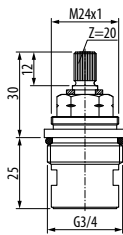
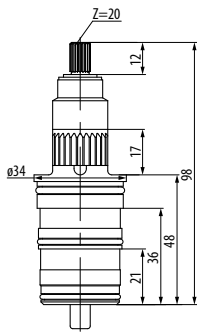

2332425Z
2332425Z

9,90

Restrictor MR05 (14L/min) • Durchflussverminderer MR05 (14 L/min)



5772135Z
5772135Z

9,60

Aerator M10x1 • Perlator M10x1



5778605Z
5778605Z

15,20

Aerator M24x1 • Perlator M24x1



5772445Z
5772445Z

31,60

Aerator M24x1 • Perlator M24x1



2206895Z
2206895Z

3,70

Key for 5772445Z • Schlüssel zu 5772445Z



5772145Z
5772145Z

5,-

Key for 5772135Z • Schlüssel zu 5772135Z

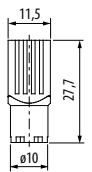
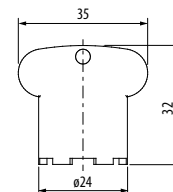
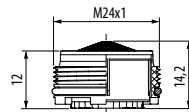
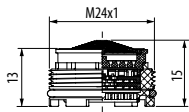
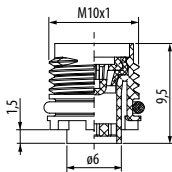
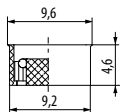

5772065Z
5772065Z

25,20

Hose G1/2 - M10x1 - 15 cm • Schlauch G1/2 - M10x1 - 15 cm



5772075Z
5772075Z

26,60

Hose G1/2 - M10x1 - 23 cm • Schlauch G1/2 - M10x1 - 23 cm



5772085Z
5772085Z

44,30

Hose G1/2 - M10x1 - 30,5 cm • Schlauch G1/2 - M10x1 - 30,5 cm

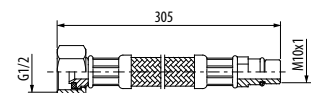
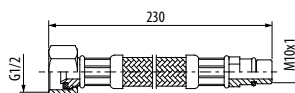
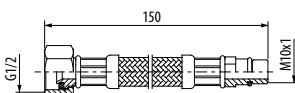

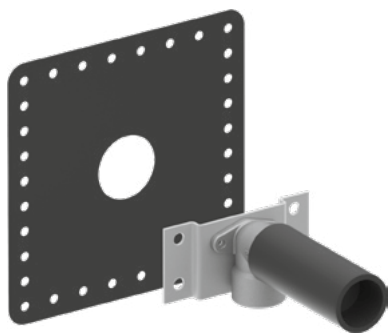

E-1041

5747370

94,-

Concealed wall elbow • Wasseranschlussbogen - UP-Teil

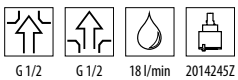

G 1/2 G 1/2 18 l/min 2014245Z

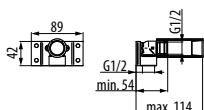

2072845Z	96	E-18002B	65	E-18013VAP.**-T	78	E-18201WCD*.-**	23	E-18213CCHP**	39
2206895Z	96	E-18002B	73	E-18013VA*.-**T	71	E-18201WCDP**	25	E-18213CTA*.-**	42
2332425Z	96	E-18002B	79	E-18013VBP.**-T	79	E-18201WCG*.-**	23	E-18213CTAP**	46
5119025Z	96	E-18002B	82	E-18013VB*.-**T	73	E-18201WCGP**	25	E-18213CTB*.-**	41
5739225Z	96	E-18002C	61	E-18014HAP.**-T	80	E-18201WCH*.-**	23	E-18213CTBP**	45
5772065Z	96	E-18002C	65	E-18014HA*.-**T	76	E-18201WCHP**	25	E-18213CTC*.-**	41
5772075Z	96	E-18002C	75	E-18014HBP.**-T	81	E-18201WTA*.-**	27	E-18213CTCP**	45
5772085Z	96	E-18002C	79	E-18014HB*.-**T	77	E-18201WTAP**	29	E-18213CTD*.-**	43
5772135Z	96	E-18002D	82	E-18014VAP.**-T	80	E-18201WTB*.-**	27	E-18213CTDP**	47
5772145Z	96	E-18002D	61	E-18014VA*.-**T	76	E-18201WTBP**	29	E-18213CTG*.-**	42
5772445Z	96	E-18002D	69	E-18014VB*.-**T	77	E-18201WTC*.-**	27	E-18213CTGP**	46
5777755Z	96	E-18002D	82	E-18014VBP.**-T	81	E-18201WTD*.-**	29	E-18213CTH*.-**	43
5777755Z	96	E-18003A	57	E-18014VA*.-**T	76	E-18201WTD**	27	E-18213CTHP**	47
5778605Z	96	E-18003A	64	E-18015HAP.**-T	80	E-18201WTD**	29	E-18214SCEP**	50
5783115Z	96	E-18003A	71	E-18015HA*.-**T	76	E-18201WTG*.-**	27	E-18214SCFP**	50
5788500	83	E-18003A	78	E-18015HBP.**-T	81	E-18201WTG**	27	E-18214SCFP**	50
5788510	82	E-18003A	78	E-18015HB*.-**T	77	E-18201WTGP**	29	E-18216CCA*.-**	34
5788520	83	E-18003A	83	E-18015VAP.**-T	80	E-18201WTH*.-**	27	E-18216CCAP**	38
5788530	82	E-18003B	59	E-18015VA*.-**T	76	E-18201WTHP**	29	E-18216CCB*.-**	33
5788540	84	E-18003B	65	E-18015VBP.**-T	81	E-18202SCAP**	49	E-18216CCBP**	37
5788550	84	E-18003B	73	E-18015VB*.-**T	77	E-18203R	49	E-18216CCC*.-**	33
5788600	83	E-18003B	79	E-18022CCP.**-T	65	E-18203SCLP**	49	E-18216CCCP**	37
5788610	82	E-18003B	83	E-18022CC*.-**T	61	E-18208CCD*.-**	35	E-18216CCD*.-**	35
5788620	83	E-18003C	61	E-18022HAP.**-T	64	E-18208CCDP**	39	E-18216CCDP**	39
5788630	82	E-18003C	65	E-18022HA*.-**T	57	E-18208CCH*.-**	35	E-18216CCG*.-**	34
5788640	84	E-18003C	75	E-18022HBP.**-T	65	E-18208CCHP**	39	E-18216CCGP**	38
5788650	84	E-18003C	79	E-18022HB*.-**T	59	E-18208CTD*.-**	43	E-18216CCH*.-**	35
E-1041	97	E-18003C	83	E-18022RDP.**-T	69	E-18208CTDP**	47	E-18216CCHP**	39
E-8605**	86	E-18003D	61	E-18022RD*.-**T	61	E-18208CTH*.-**	43	E-18216CTA*.-**	42
E-8605**	88	E-18003D	69	E-18022VAP.**-T	64	E-18208CTHP**	47	E-18216CTAP**	46
E-8605**	90	E-18003D	83	E-18022VA*.-**T	57	E-18210CCA*.-**	34	E-18216CTB*.-**	41
E-8605**	92	E-18004A	62	E-18022VBP.**-T	65	E-18210CCAP**	38	E-18216CTBP**	45
E-8618C*.-**	87	E-18004A	66	E-18022VB*.-**T	59	E-18210CCB*.-**	33	E-18216CTC*.-**	41
E-8618CP**	89	E-18004A	76	E-18023CCP.**-T	65	E-18210CCBP**	37	E-18216CTCP**	45
E-8618T*.-**	91	E-18004A	80	E-18023CC*.-**T	61	E-18210CCC*.-**	33	E-18216CTD*.-**	43
E-8618TP**	93	E-18004A	84	E-18023HAP.**-T	64	E-18210CCCP**	37	E-18216CTDP**	47
E-8697C*.-**	86	E-18004B	63	E-18023HA*.-**T	57	E-18210CCD*.-**	35	E-18216CTG*.-**	42
E-8697CP**	88	E-18004B	67	E-18023HBP.**-T	65	E-18210CCDP**	39	E-18216CTGP**	46
E-8697T*.-**	90	E-18004B	77	E-18023HB*.-**T	59	E-18210CCG*.-**	34	E-18216CTH*.-**	43
E-8697TP**	92	E-18004B	81	E-18023RDP.**-T	69	E-18210CCGP**	38	E-18216CTHP**	47
E-8706C*.-**	86	E-18004B	84	E-18023RD*.-**T	61	E-18210CCH*.-**	35	E-18216SCEP**	50
E-8706CP**	88	E-18005A	62	E-18023VAP.**-T	64	E-18210CCHP**	39	E-18216SCEP**	50
E-8706T*.-**	90	E-18005A	66	E-18023VA*.-**T	57	E-18210CTA*.-**	42	E-18218SCEP**	50
E-8706TP**	92	E-18005A	76	E-18023VBP.**-T	65	E-18210CTAP**	46	E-18218SCEP**	50
E-8713C*.-**	87	E-18005A	80	E-18023VB*.-**T	59	E-18210CTB*.-**	41	E-19401C*.-**	87
E-8713CP**	89	E-18005A	84	E-18024HAP.**-T	66	E-18210CTBP**	45	E-19401CP**	89
E-8713T*.-**	91	E-18005B	63	E-18024HA*.-**T	62	E-18210CTC*.-**	41	E-19401T*.-**	91
E-8713TP**	93	E-18005B	67	E-18024HBP.**-T	67	E-18210CTCP**	45	E-19401TP**	93
E-8751C*.-**	86	E-18005B	77	E-18024HB*.-**T	63	E-18210CTD*.-**	43	E-19404C*.-**	87
E-8751CP**	88	E-18005B	81	E-18024HBP.**-T	66	E-18210CTDP**	47	E-19404CP**	89
E-8751T*.-**	90	E-18005B	84	E-18024VAP.**-T	62	E-18210CTD*.-**	42	E-19404T*.-**	91
E-8751TP**	92	E-18012CCP.**-T	79	E-18024VA*.-**T	66	E-18210CTG*.-**	46	E-19404TP**	93
E-8752*.-**	87	E-18012CC*.-**T	75	E-18024VBP.**-T	67	E-18210CTH*.-**	43	E-19407C*.-**	87
E-8752P**	89	E-18012HAP.**-T	78	E-18024VB*.-**T	63	E-18210CTHP**	47	E-19407CP**	89
E-8762*.-**	91	E-18012HA*.-**T	71	E-18025HAP.**-T	66	E-18210CTH*.-**	47	E-19407T*.-**	91
E-8762P**	93	E-18012HBP.**-T	79	E-18025HA*.-**T	62	E-18210SCDP**	51	E-19407TP**	93
E-8804**	88	E-18012HB*.-**T	73	E-18025HBP.**-T	67	E-18210SCLP**	51	E-19408C*.-**	87
E-8804C*.-**	86	E-18012VAP.**-T	78	E-18025HB*.-**T	63	E-18213CCA*.-**	34	E-19408CP**	89
E-8814**	92	E-18012VAP**	78	E-18025VAP.**-T	66	E-18213CCAP**	38	E-19408CP**	89
E-8814T*.-**	90	E-18012VA*.-**T	71	E-18025VBP.**-T	62	E-18213CCB*.-**	33	E-19408T*.-**	91
E-18002A	57	E-18012VBP**	79	E-18025VA*.-**T	67	E-18213CCBP**	37	E-19408TP**	93
E-18002A	64	E-18012VB*.-**T	73	E-18025VBP.**-T	67	E-18213CCC*.-**	33	E-19409C*.-**	87
E-18002A	71	E-18013CCP.**-T	79	E-18025VB*.-**T	63	E-18213CCCP**	37	E-19409CP**	89
E-18002A	78	E-18013CC*.-**T	75	E-18201WCA*.-**	25	E-18213CCD*.-**	35	E-19409T*.-**	91
E-18002A	82	E-18013HAP.**-T	78	E-18201WCB*.-**	23	E-18213CCDP**	39	E-19409TP**	93
E-18002B	59	E-18013HA*.-**T	71	E-18201WCBP**	25	E-18213CCG*.-**	34		
		E-18013HBP**	79	E-18201WCC*.-**	23	E-18213CCGP**	38		
		E-18013HB*.-**T	73	E-18201WCCP**	25	E-18213CCH*.-**	35		



GENERAL SALES CONDITIONS ALLGEMEINE GESCHÄFTSBEDINGUNGEN

EN GRAFF General Terms and Conditions of Sales

I. General Provisions

- These General Terms and Conditions of Sales (further also referred to as the GTCS) apply to all sales transactions conducted by GRAFF and constitute an integral part of these transactions. These GTCS shall not apply to sales transactions conducted with final consumers (products users).
- These GTCS are publicly available at www.graff-mixers.com, and this information is communicated to the Buyer before the agreement is concluded. By signing the agreement or placing an order, the Buyer acknowledges that they have read and understood the GTCS and agrees to apply and use all conditions.
- If the Buyer is in a business relationship with Graff but has not signed the trade cooperation agreement, the Buyer's acceptance of the GTCS for one order shall be considered their acceptance for the remaining orders.
- If the Buyer has submitted a statement of non-acceptance of the GTCS, Graff retains the right to suspend the release of merchandise until it receives the Buyer's written statement of acceptance of the GTCS.
- Graff does not accept the GTCS prepared and applied by the Buyer insofar as they are inconsistent with or different from these GTCS. The only exception is the situation where Graff agrees in writing to accept the Buyer's GTCS.

II. Conclusion of the Agreement

- The essential trade terms applicable in a given period between Graff and the Buyer are described in the trade cooperation agreement signed by both Parties. The Signing of this trade cooperation agreement shall be tantamount to the Buyer's acceptance of the GTCS. To the extent not regulated by the agreement, the GTCS shall apply.
- In the absence of the trade cooperation agreement, the document that binds the Parties shall be the Buyer's written order confirmed by Graff within 2 business days following the receipt thereof. In the absence of such confirmation, the order shall be deemed not accepted. In the confirmation of the order Graff confirms final terms applicable to sales (if for any reason they may differ from the previously agreed ones).
- The order should state the following: detailed name and address of the Buyer; ordered products and their quantities; date and place of the delivery; agreed form and date of payment. The order should bear the company stamp and be signed by a person authorised to place orders on behalf of the Buyer.
- Price lists, advertisements and other sales literature concerning Graff's merchandise are for informational purposes only and shall not be considered binding.

III. Prices and Terms of Payment

- Retail prices stated by Graff in the price list are net prices (i.e. excluding VAT applicable on a given territory) and they do not include costs of merchandise transport to the destination.
- When so desired by the Customer, Graff may organise transport of merchandise to the Customer-specified location in which case all related costs are borne by the Customer unless agreed on by prior written consent. Graff retains the exclusive right to select the transportation method and carrier. As soon as the buyer receives merchandise, the Buyer shall be obliged to notify Graff in writing about any and all damage to the merchandise while in transit. Merchandise will be insured for the time of transport against damage, theft or destruction at the Buyer's expense.
- The selling price for the Buyer shall be based on the price list that is valid on the order placement date. The selling price shall be the list price reduced by an applicable discount only when the discount has been confirmed by Graff in writing (by way of the agreement or order confirmation).
- The Buyer may be granted a sales discount consisting of a reduction to the net list price, and the display discount i.e. special reduction of the net list price applicable to the Buyer's purchase of products for their own display.
- Graff reserves the right to change the list prices without prior notice to the Buyer. The change of the price shall not apply to confirmed orders.
- The entire payment for all received merchandise should be concluded within the time limit specified in the agreement or the invoice. Should the time limit specified in the agreement and the invoice be at variance, payment should be effected at the earlier thereof. In each case the time limit for payment shall be calculated from the invoice date.
- The Buyer's payment date shall be the date when the receive-

ble is credited to Graff's account.

- Lodging a complaint shall not authorise the Buyer to withhold payment for the merchandise or a part thereof.
- In its relationship with Graff, the Buyer shall not have the right to make a unilateral statement on offsetting.
- Should the payment be delayed, Graff retains the right to charge 8% of interest for the delay.
- Should the Buyer exceed the time limit for payment for the delivered merchandise under at least one invoice, Graff shall have the right to call for immediate payment of the remaining invoices whose payment deadlines have not expired yet.
- If the payment amounts due are delayed, Graff shall have the right to withhold processing of other orders placed by the Buyer. If the delays in payments recur or if it is unilaterally ascertained that the Customer is insolvent, Graff shall have the right to terminate the sales agreement immediately.

IV. Delivery Terms

- Delivery of the merchandise ordered by the Buyer is effectively based on the Buyer's order and Graff's confirmation of the order acceptance. Should the order and confirmation of the order acceptance be at variance, the latter shall prevail. The deadline for delivery shall run from the date of confirmation of the order acceptance and not from the order placement date. The deadline for delivery shall be deemed kept if the merchandise leaves Graff's warehouse before it has passed.
- Graff reserves the right to postpone the deadline for delivery without any consequences whatsoever if the Buyer has payments to Graff in arrears for the merchandise that they have already collected.
- Graff shall indicate the anticipated deadline for delivery in writing. Should the deadline for delivery be not confirmed, Graff will make every effort in order to prepare merchandise for collection, taking into account the Buyer's interests.
- Should the delivery of merchandise be prevented due to a force majeure event that has affected Graff or its suppliers, the Buyer shall have no right to claim for the redress of the damage resulting from non-performance or delayed performance of the agreement. Force majeure events should be understood in particular as business disturbances affecting the manufacturer of merchandise, strikes, shortage of materials, labour or transport vehicles and natural disasters.
- The Buyer may refuse to accept partial deliveries. Graff shall be obliged to obtain the Buyer's written consent for a partial delivery. A partial delivery should be invoiced in parts.
- Return of the merchandise that has been delivered in line with the confirmed order and without previous arrangement of such return with Graff shall not be allowed. Merchandise that has been sent back to Graff's warehouse without Graff's knowledge will not be accepted from the carrier. In the case of the approved return of the merchandise already purchased by the Customer, the merchandise will be burdened with 30% of the invoiced price against warehouse handling costs. Graff shall not accept the merchandise other than in the original sealed packaging.
- The return of defective merchandise shall be an exception to the provisions of item IV.6.

V. Complaints

- Complaints related to visible damage to the merchandise or their packaging in transport should be lodged as early as possible in the presence of the carrier's representative under loss of claim thereunder. Such complaints should be also recorded in the carrier's receipt.
- Quantitative complaints should be lodged as early as possible in the presence of the carrier's representative under pain of loss of claim thereunder. While receiving each shipment the Buyer shall be obliged to check received quantities, immediately record missing quantities (if any) in the carrier's receipt and report them to Graff.
- Complaints lodged by final customers should be pre-verified by relevant personnel of the Buyer and then immediately, i.e. within 24 hours following their report by the final customer, reported to Graff.
- All complaints should be lodged in writing. A complaint should be lodged with a photograph about the defect to the product and a short description of the defect itself.
- Should the complaint be admitted, Graff shall be obliged to remove the defect. It is Graff that decides at its own discretion how to remove the defect.

- The Buyer shall be obliged to store all defective merchandise with due diligence and in a way that prevents their further damage or loss until the complaint is finally settled.
- If no complaints are lodged in a form and within time limits indicated in the General Terms and Conditions of Sales and a warranty, the Buyer shall lose its right to return the merchandise.
- Graff's liability for damage inflicted on the Buyer shall be exclusively limited to the value of the order.

VI. Retention of Title

- Graff retains the title to the sold merchandise until the Buyer makes all payments due under the agreement.
- The Buyer shall be obliged to notify Graff about any retained merchandise that is a result of enforcement proceedings against the Buyer or its property.
- If the Buyer fails to pay for merchandise within the agreed time limit, Graff shall be entitled to demand the return of such merchandise from the Buyer. Should the merchandise be used or damaged, Graff shall be entitled to claim for compensation thereunder.

VII. Liability

- Graff shall not be held liable for improper use of its products. It shall also not be held liable for improper (not in agreement with the included written instructions) assembly of the product and its installation.
- Graff shall be held liable for damage caused by its products but only when it results from malicious intent or negligence on the part of Graff. Graff shall not be held liable for negligence of its employees or business partners.
- In each case Graff's liability shall be limited to circumstances that are known or foreseeable at the time when the agreement is concluded.
- Graff shall not be held liable for the loss of benefit by the Buyer or third parties. Graff shall not be held liable either if any actions are brought against the Buyer by third parties.

VIII. Termination of the Agreement

- If Graff and the Buyer have concluded the trade cooperation agreement, each Party may terminate it in writing, giving the other Party 30 days' notice.
- In the absence of the trade cooperation agreement, Graff may terminate the agreement concluded by way of written confirmation of the order immediately should it be unable to execute the order for reasons beyond its control.

IX. Final Provisions

- The agreement conducted by the Parties and/or the GTCS shall be governed by the governing laws effective in the country where the invoice for Graff's products was issued.
- The Parties exclude application of the United Nations Convention on the International Sale of Goods.
- All disputes arising in connection with the GTCS or the trade cooperation agreement (if any) shall be unanimously submitted by the Parties to the court having jurisdiction over Graff's invoice drawer.
- In the case of the Buyer's change of address, the Buyer shall be obliged to communicate the new address to Graff in writing. Should the Buyer fail to do so, all communications sent to the previous address shall be considered effectively given.
- If one or more provisions of the GTCS become invalid, the validity of the remaining provisions of the GTCS shall remain intact.

DE Allgemeine Verkaufsbedingungen GRAFF

I. Allgemeine Bestimmungen

1. Diese Allgemeinen Verkaufsbedingungen (nachstehend auch „AVB“ genannt) finden für alle durch GRAFF (nachstehend auch VERKÄUFER bzw. GRAFF genannt) geschlossenen Verkaufstransaktionen Anwendung und bilden ihren integralen Teil. Diese AVB finden keine Anwendung bei Verkaufstransaktionen die mit Verbrauchern (Endnutzern) geschlossen werden.
2. Diese AVB sind auf der Internetseite www.graff-mixers.com allgemein zugänglich, worüber der Käufer vor der Vertragsschließung in Kenntnis gesetzt wird. Durch die Vertragsunterzeichnung bzw. die Bestellung erklärt der Käufer, dass ihm die AVB bekannt sind sowie dass der Käufer ihren Inhalt versteht und ihnen zustimmt.
3. Wenn der Käufer eine dauerhafte Geschäftsbeziehung zu Graff pflegt, jedoch keinen Vertrag über geschäftliche Zusammenarbeit unterzeichnet hat, gilt die Zustimmung des Käufers zu den AVB bei einer Bestellung als Zustimmung bei weiteren Bestellungen.
4. Wenn der Käufer erklärt hat, dass er den AVB nicht zustimmt, hat Graff das Recht die Herausgabe der Ware einzubehalten bis eine schriftliche Erklärung des Käufers über die Zustimmung zu den AVB bei Graff eingegangen ist.
5. Graff akzeptiert keine durch den Käufer erstellten und angewendeten AVB, soweit sie diesen AVB widersprechen bzw. wenn sie von diesen abweichen. Die einzige Ausnahme hierzu bildet die Situation, wenn Graff eine schriftliche Zustimmung zu den AVB des Käufers erklärt.

II. Vertragsschließung

1. Die in dem jeweiligen Zeitraum zwischen Graff und dem Käufer geltenden grundsätzlichen Geschäftsbedingungen sind in einem durch beide Parteien unterzeichneten Vertrag über geschäftliche Zusammenarbeit festgelegt. Die U-Verzeichnung eines solchen Vertrages ist der Zustimmung des Käufers zu den AVB gleichzusetzen. In Angelegenheiten die durch den Vertrag nicht geregelt sind finden die AVB Anwendung.
2. Wenn kein unterzeichneter Vertrag über geschäftliche Zusammenarbeit vorliegt, gilt die schriftliche Bestellung des Käufers als bindend für die Parteien die durch Graff innerhalb von 2 Geschäftstagen nach dem Erhalt bestätigt wird. Wenn keine solche Bestätigung vorliegt, gilt die Bestellung als nicht angenommen. In der Beststellungsbestätigung bestätigt Graff die endgültigen Verkaufsbedingungen (wenn diese aus irgendeinem Grund von den früher vereinbarten Bedingungen abweichen können).
3. Die Bestellung soll Folgendes beinhalten: Name und Anschrift des Käufers, Sortiment und Anzahl der bestellten Waren, Ort und Termin der Lieferung, vereinbarte Zahlungsform und Zahlungstermin. Die Bestellung muss mit einem Firmensiegel versehen sein und muss von einer zur Bestellung im Namen des Käufers berechtigten Person unterzeichnet werden.
4. Preislisten, Werbungen und andere Anzeigen über die von Graff angebotenen Waren sind nur für Informationszwecke bestimmt.

III. Preise und Zahlungsbedingungen

1. Die durch Graff in der Preisliste angegebenen Einzelhandelspreise sind Nettopreise (ohne die auf dem jeweiligen Territorium geltende Mehrwertsteuer) abzüglich der Kosten für den Transport der Waren zum Bestimmungsort.
2. Auf Kundenwunsch kann Graff den Transport der Ware zu einem vom Kunden bestimmten Ort organisieren, jedoch hat der Kunde alle damit verbundenen Kosten zu tragen. Die Auswahl der Transportart und der Spedition hat Graff zu treffen. Unverzüglich nach der Warenabnahme ist der Käufer verpflichtet Graff über alle bei dem Transport entstandenen Beschädigungen der Ware in Kenntnis zu setzen. Die Ware wird für den Transport gegen Beschädigung, Diebstahl oder Zerstörung auf Kosten des Käufers versichert.
3. Der Verkaufspreis für den Käufer wird auf der Grundlage der am Bestimmungstag geltenden Preisliste bestimmt. Der Verkaufspreis wird durch Senkung des Preises auf der Preisliste um einen eventuellen Rabatt nur dann bestimmt, wenn dieser durch Graff schriftlich bestätigt wurde (in Form eines geschlossenen Vertrages bzw. in der Beststellungsbestätigung).
4. Dem Käufer kann ein Geschäftsrabatt, d.h. Senkung des Nettopreises auf der Preisliste sowie ein Ausstellungsrabatt gewährt werden, d.h. ein Sondernachlass des Nettopreises auf der Preisliste, wenn der Käufer die Produkte für seine eigene Ausstellung erwirbt.
5. Graff behält sich das Recht vor die Preise auf der Preisliste zu ändern ohne darüber den Käufer vorher zu benachrichtigen.

Die Preisänderung gilt nicht für die bereits bestätigten Bestellungen.

6. Die Zahlung für die erhaltene Ware hat in voller Höhe und zu einem vertraglich bzw. auf der ausgestellten Rechnung festgelegten Termin zu erfolgen. Bei Diskrepanzen zwischen dem vertraglich festgelegten Termin und dem Termin auf der Rechnung, hat die Zahlung zu dem jeweils früheren Termin zu erfolgen. In jedem Fall läuft der Zahlungstermin ab dem Ausstellungstag der Rechnung.
7. Als Zahlungstag des Käufers gilt der Tag an dem der fällige Betrag auf das Konto von Graff eingegangen ist.
8. Die Meldung einer Beanstandung berechtigt den Käufer nicht dazu die Zahlung des Preises für die Ware bzw. einen Teil der Ware einzubehalten.
9. Der Käufer hat kein Recht darauf gegenüber Graff eine einseitige Erklärung über Abzug abzugeben.
10. Bei Zahlungsverzug hat Graff das Recht, Verzugszinsen in Höhe von 8% jährlich zu berechnen.
11. Bei einer Überschreitung des Zahlungstermins für die gelieferte Ware seitens des Käufers, die sich aus mindestens einer Rechnung ergibt, hat Graff die sofortige Zahlung der übrigen Rechnungen zu fordern deren Zahlungstermine noch nicht abgelaufen sind.
12. Bei Zahlungsverzug hat Graff das Recht, die Ausführung anderer Bestellungen des Käufers einzubehalten. Bei sich wiederholenden Zahlungsverzögerungen bzw. bei einer einseitigen Feststellung der Insolvenz des Kunden, hat Graff das Recht den Verkaufsvertrag sofort zu kündigen.

IV. Lieferungsbedingungen

1. Die Lieferung der vom Käufer bestellten Ware erfolgt auf der Grundlage seiner Bestellung sowie einer Bestätigung der Bestellungsannahme durch Graff. Bei Diskrepanzen zwischen der Bestellung und der Bestätigung der Bestellungsannahme, ist der Inhalt der Bestätigung der Bestellungsannahme ausschlaggebend. Die Lieferungsfrist läuft ab dem Tag der Beststellungsbestätigung und nicht ab dem Tag der Bestellsabgabe. Die Lieferungsfrist gilt als eingehalten, wenn vor ihrem Ablauf die Ware das Lager von Graff verlässt.
2. Graff behält sich das Recht vor den Lieferungsfrist ohne jegliche Konsequenzen zu verschieben, wenn der Käufer mit seinen Zahlungen für früher abgenommene Waren im Rückstand ist.
3. Graff teilt den voraussichtlichen Lieferungsfrist schriftlich mit. Wenn keine schriftliche Terminbestätigung vorliegt, wird Graff alle erforderlichen Maßnahmen ergreifen, um die Ware unter Berücksichtigung der Interessen des Käufers für die Abnahme vorzubereiten.
4. Wenn die Unmöglichkeit der Warenlieferung auf höhere Gewalt, die Graff bzw. seine Lieferanten betrifft, zurückzuführen ist, hat der Käufer keinerlei Ansprüche auf Behebung des Schadens wegen Nichterfüllung bzw. nicht termingemäßer Erfüllung des Vertrages. Als Ereignisse aufgrund höherer Gewalt sind insbesondere Störungen im Geschäft des Warsherstellers, Streiks, Mangel an Materialien, Arbeitskräften und Transportmitteln sowie Naturkatastrophen zu verstehen.
5. Der Käufer darf die Annahme von Teillieferungen verweigern. Graff ist verpflichtet eine schriftliche Zustimmung des Käufers zu einer Teillieferung einzuholen. Die Teillieferung soll auch teilweise fakturiert werden.
6. Die Rückgabe einer gemäß der bestätigten Bestellung gelieferten Ware ohne eine frühere Absprache mit Graff, ist nicht möglich. Waren die ohne die Kenntnis von Graff zurück zum Lager von Graff verschickt werden, werden von der Spedition nicht abgenommen. Bei Zustimmung zu der Rückgabe einer vom Kunden erworbenen Ware, wird ihm ein Betrag in Höhe von 30% des fakturierten Preises aus den Kosten der Lagerdieneung angerechnet. Graff wird nur solche Waren annehmen, die in versiegelten Originalverpackungen geliefert werden.
7. Eine Ausnahme der Bestimmungen des Punktes IV.6 bildet die Rückgabe einer mangelhaften Ware.

V. Beanstandungen

1. Beanstandungen, die sichtbare Transportbeschädigungen der Ware bzw. ihrer Verpackung betreffen, sind in Anwesenheit eines Vertreters der Spedition zu melden, unter Androhung des Verfalls des Rechts auf die sich daraus ergebenden Ansprüche. Solche Beanstandungen sind auch auf dem Abnahmeprotokoll der Spedition zu vermerken.
2. Beanstandungen von quantitativen Mängeln sind in Anwesenheit eines Vertreters der Spedition zu melden, unter Androhung des Verfalls des Rechts auf die sich daraus ergebenden Ansprüche. Bei Abnahme einer Sendung ist der Käufer verpflichtet, eine quantitative Prüfung der Sendung

vorzunehmen und eventuelle Mängel unverzüglich auf dem Abnahmeprotokoll der Spedition zu vermerken und Graff darüber in Kenntnis zu setzen.

3. Durch den Endkunden gemeldete Beanstandungen sind durch den entsprechenden Dienst des Käufers vorläufig zu überprüfen und danach unverzüglich, innerhalb von 24 Stunden nach der Meldung durch den Endkunden, bei Graff zu melden.
4. Alle Beanstandungen haben schriftlich zu erfolgen. Der Beanstandungsmeldung sind ein Foto des Produktmangels sowie eine kurze Beschreibung des Mangels beizufügen.
5. Wenn die Beanstandung als gerechtfertigt anerkannt wird, ist Graff verpflichtet den Mangel zu beheben. Über die Methode zur Behebung des Mangels entscheidet ausschließlich Graff.
6. Bis zu einer abschließenden Überprüfung der Beanstandung ist der Käufer verpflichtet die beanstandete Ware mit gebotener Sorgfalt so aufzubewahren, dass eine weitere Beschädigung bzw. weitere Mängel an der Ware verhindert werden.
7. Wenn keine Beanstandung gemäß den in den Allgemeinen Verkaufsbedingungen und in der Garantiekarte festgelegten Formen und Terminen gemeldet wird, verliert der Käufer das Recht die Ware zu beanstanden.
8. Für Schäden des Käufers die Graff zu verantworten hat, haftet Graff nur für die Höhe des Bestellwertes.

VI. Eigentumsvorbehalt

1. Graff behält sich das Eigentumsrecht an der verkauften Ware bis zur Begleichung sämtlicher aus dem Vertrag sich ergebenden Forderungen durch den Käufer vor.
2. Der Käufer ist verpflichtet Graff über die Beschlagnahme der Ware in einem Vollstreckungsverfahren, das den Käufer bzw. sein Vermögen betrifft, zu benachrichtigen.
3. Wenn der Käufer keine Zahlung für die Ware zu dem vereinbarten Termin leistet, hat Graff das Recht, Warenrückgabe von dem Käufer zu fordern. Bei Abnutzung bzw. Beschädigung der Ware hat Graff das Recht, die sich daraus ergebende Entschädigung in Anspruch zu nehmen.

VII. Haftung

1. Graff übernimmt keine Haftung für unsachgemäße Nutzung seiner Produkte. Graff übernimmt auch keine Haftung für unsachgemäßen (nicht gemäß der Anleitung durchgeführten) Zusammenbau des Produktes sowie dessen Montage durch nicht qualifizierte Monteur.
2. Graff haftet für die durch seine Produkte verursachten Schäden, jedoch nur dann, wenn der Schaden auf böswillige Absicht bzw. Versäumnis zurückzuführen ist. Graff übernimmt keine Haftung für Versäumnisse der Mitarbeiter bzw. Partner.
3. In jedem Fall beschränkt sich die Haftung von Graff auf solche Umstände, die zum Zeitpunkt der Vereinbarung bekannt bzw. vorhersehbar waren.
4. Graff übernimmt keine Haftung für entgangenen Gewinn gegenüber dem Käufer und anderen Parteien. Graff übernimmt keine Haftung für Klagen Dritter gegen den Käufer.

VIII. Auflösung des Vertrags

1. Wenn Graff und der Käufer einen Vertrag über geschäftliche Zusammenarbeit geschlossen haben, kann jede Partei diesen schriftlich unter Einhaltung einer 30-tägigen Kündigungsfrist kündigen.
2. Wenn kein unterzeichneter Vertrag über geschäftliche Zusammenarbeit vorliegt, kann Graff den durch die Bestellbestätigung geschlossenen Vertrag sofort kündigen, wenn die Ausführung der Bestellung aus Gründen die er nicht zu verantworten hat nicht möglich ist.

IX. Schlussbestimmungen

1. Ein durch die Parteien geschlossener Vertrag und/oder die AVB unterliegen dem Landesrecht, in dem die Rechnungen für die Produkte von Graff ausgestellt wurden.
2. Die Parteien schließen die Anwendung des Übereinkommens der Vereinten Nationen über die Verträge im internationalen Warenverkauf aus.
3. Die Regelung aller, welche sich aus den AVB bzw. aus dem Vertrag über die geschäftliche Zusammenarbeit, wenn diese geschlossen wurde, ergebenden Streitigkeiten übertragen die Parteien auf das zuständige Gericht für den Standort von Graff, der die Rechnung ausgestellt hat.
4. Bei Änderung der Anschrift des Käufers hat der Käufer Graff schriftlich zu benachrichtigen. Bei Nichterfüllung dieser Pflicht, gilt die an die bisherige Anschrift verschickte Korrespondenz als richtig zugestellt.
5. Sollten sich einige Bestimmungen der AVB als nichtig erweisen, so hat dies keinen Einfluss auf die Gültigkeit der übrigen Bestimmungen der AVB.





Graff-designs.com



Website

#graff_designs



Instagram

Contact us :

USA Customer Care:

sales@graff-designs.com, toll free: +1 800 954 4723

EU Customer Care:

info@graff-designs.com, tel: +39 055 9332115

Technical Office:

technical@graff-designs.com, tel: +39 0322 341234

Disclaimer: The images and descriptions in the price book do not constitute an obligation of an accurate realization of the product. The details and measurements included are to be used as a guide and maybe modified without prior notice. Possible mistakes / misprints in the price book cannot be an object of dispute.